

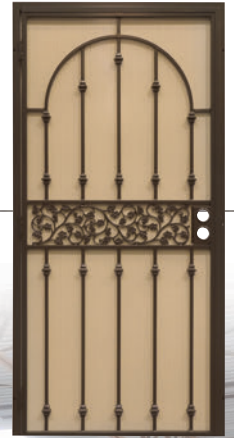

1  
Swinging Screen



22 Water Jet



24 Steel Security



Page

iii | ABOUT US

1 | SECTION 1  
Swinging Screen Doors

18 | SECTION 2  
Domestic Steel Security Doors

Page

61 | SECTION 3  
Economy Steel Security Doors

66 | SECTION 4  
Sliding Screen Doors

78 | SECTION 5  
Door Grilles & Accessories



66 Sliding Screen

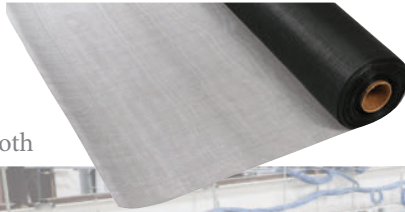

84 Screen Cloth



103 Tools



# CONTENTS

Page

**82** | SECTION 6  
Pet Doors & Accessories

**84** | SECTION 7  
Screen Cloth, Roll Goods & Spline

**90** | SECTION 8  
Window Screen Frame &  
Components

Page

**103** | SECTION 9  
Tools & Supplies



# ABOUT US...

## PRECISION

For over 65 years, Precision has been known for manufacturing quality window and door products as well as other hardware for the commercial and home consumer market.

Our innovative manufacturing process allows us to offer a wide assortment of product offerings including:

- Steel security doors
- Custom security doors
- Swinging screen doors
- Sliding screen doors
- Custom gates and fencing
- Commercial gates and fencing
- Window guards
- Protective grills
- KD kits

Precision has long been known for its “one-call” service, and we continue to expand our capabilities to provide the most innovative and broadest selection at a great value.

Our customer promise:

- Provide the best customer service in the industry
- Focus on quality and value
- Industry knowledge leader
- Maintain extensive product assortment
- Continue to bring innovation to the market
- Inventory on-hand and ready to ship on stock items
- Nationwide coverage



---

## TO OUR VALUED CUSTOMERS:

Your account#: \_\_\_\_\_

Phone: \_\_\_\_\_

Your sales representative is: \_\_\_\_\_

Fax: \_\_\_\_\_

Your delivery days are:  Mon.  Tues.  Wed.  Thurs.  Fri.

### Hours of Operation:

7 am – 4 pm, Monday – Friday

# TERMS AND CONDITIONS

## PRICES & ORDERING

Prices do not include freight, taxes and duties and are subject to change without notice. Typographical errors are subject to correction. Items will be invoiced at prices current at the time of shipment. Minimum order \$25.00.

Any quotes are valid for 30 days from the time of written quotation unless otherwise stated.

All orders are accepted subject to availability of merchandise. Orders must be modified or canceled within one (1) hour of entry or fees may apply. All orders are confirmed via fax or e-mail, and are the customer's responsibility to verify. All orders will be accepted on a ship and cancel basis, unless otherwise requested.

Due to engineering upgrades and manufacturing variance, the actual replacement part may or may not look identical to the representative illustration.

Special orders are non-cancelable, non-returnable and must be ordered via a purchase order from the Purchaser. All special orders will be shipped in accordance with quoted lead times. Minimum order quantities may be required on special orders or bulk orders. Bulk orders may be shipped at industry standard  $\pm 10\%$  of the order quantity. Purchaser is liable for the entire order quantity. Special discounting is available on large quantity orders; call (866) 629-6636 for pricing and availability.

## CUSTOM ORDERS

A signed confirmation must be received by Precision Screen & Security Products before any custom orders are scheduled for production. Precision is not responsible for any errors and/or omissions in customer verified information.

COD Custom Orders: All COD custom orders must have a 50% non-refundable deposit towards the total invoice value before production takes place.

## TERMS

Precision Screen & Security Products accepts Visa, MasterCard, American Express, Discover, Diner's Card and Cash On Delivery (COD). For customers with established Precision Screen & Security Products credit, payment terms are net thirty (30) days from the date of shipment or pick-up of products. Credit application must be completed in full. All credit extended by Precision Screen & Security Products and the limits of such credit, is at Precision Screen & Security Products' sole discretion, and may be reduced or revoked by Precision Screen & Security Products at any time, for any reason. Precision Screen & Security Products reserves the right to charge customer a late payment fee at the rate of one and one-half percent (1.5%) of the amount due for each month or portion thereof that the amount due remains unpaid, or such amount as may be permitted under applicable law.

Precision Screen & Security Products has the right, at any time and in its sole discretion, to immediately change the terms of any credit extended to customer if: (i) there is a material change in customer's financial capability or creditworthiness; (ii) customer enters into or signs an agreement regarding any Change of Control; or (iii) a trustee, receiver or examiner is appointed for customer or its affiliates or subsidiaries or customer's plan of reorganization is confirmed by a U.S. Bankruptcy Court.

Additionally, customer, and each of its subsidiaries and affiliates, agrees to provide to Precision Screen & Security Products proper

authorization necessary for Precision Screen & Security Products to request any financial information from third parties.

## FREIGHT

Prices stated are F.O.B. origin, freight prepaid to destination specified in the order.

Precision Screen & Security Products covers shipping and handling for standard ground delivery for orders within a 100-mile radius and over US \$225 before tax and freight (including any backorders). Please call to obtain current delivery schedules and delivery minimums for other delivery points. All shipments outside of PSSP delivery areas will be shipped via "common carrier" collect at customer's expense. "Job Site" or "Drop Shipment" deliveries are available in some areas on normal scheduled delivery days. A "Job Site" or "Drop Shipment" fee will apply. All COD job site deliveries shall be paid prior to the delivery.

Where Precision Screen & Security Products is the carrier, claims for damaged material, shortages or errors must be reported within five (5) working days after receipt of shipment. All claims reported after the five working day grace period will be subject to Precision authorization. All claims must be processed within thirty (30) calendar days.

Other terms and conditions may apply for other than standard ground delivery.

Accessorial Charges, including but not limited to over size and residential delivery charges, will be passed through from the carrier and must be paid by customer. Fuel surcharges may be applied.

Title and all risk of damage or loss pass to customer upon tender of shipment to the carrier. Our obligation to effect shipment of products will be fully discharged upon delivery to the carrier. If the product is damaged in transit, customer's only recourse is to file a claim with the carrier.

Precision will not be responsible for any failure to perform due to causes beyond its reasonable control (each, a "Force Majeure") including, but not limited to, acts of God, war, riot, embargoes, acts of civil or military authorities, denial of or delays in processing of export license applications, fire, floods, earthquakes, accidents, strikes, or fuel crises, provided that Precision gives prompt written notice thereof. The time for performance will be extended for a period equal to the duration of the Force Majeure, but in no event longer than sixty (60) days.

## RETURNS

Items must be returned within 30-days from date of purchase. No returns will be accepted without pre-authorization from Precision Screen & Security Products. Contact Customer Service at (866) 629-6636 for a return authorization number. A freight and restocking charge (15%) may be applied. Obsolete or discontinued items may not be accepted. NON-STOCKED, CUSTOM OR SPECIAL ORDER PRODUCTS CANNOT BE RETURNED. All items that arrive with damaged packaging will be subject to a \$20.00 re-packaging fee. DAMAGED PRODUCTS ARE NOT RETURNABLE, NO EXCEPTIONS.

## ACCEPTANCE

Placement of an order constitutes acceptance of these terms and conditions.



# LIMITED WARRANTY

Except as provided below, Precision Screen & Security Products warrants this product solely against defects in material and workmanship for 1 year from the date of purchase and will refund the purchase price or offer product replacement only. Claimant must provide copy of purchase receipt and supply at claimant's expense product for inspection at Precision's normal place of business unless otherwise agreed. Precision expressly disclaims any, and makes no, representation about the suitability of this product for any purpose, and, except for the limited warranty expressly set forth above, or to the extent restricted or prohibited by law, makes no warranties, either express or implied, including quality, merchantability and fitness for a particular purpose. Precision agrees only to replace the product or to refund the purchase price, at its sole discretion, in the event a claim is accepted, and in no event will Precision be liable for an amount in excess of the payments received by Precision, or for any direct, indirect, incidental, special, punitive, consequential, or exemplary damages (including but not limited to lost profits, revenue, data, lost goodwill, cost of procurement of substitute equipment or property incurred by you or any third party, arising from product failure.) Any tampering, negligence or use in a manner other than intended invalidates this warranty.

- **PRODUCTS INSTALLED WITHIN 5 MILES OF ANY COASTAL REGION, OR SUBJECTED TO EXCESSIVE AND/OR CONSISTENT, MOISTURE CANNOT BE WARRANTED AGAINST RUST OR CORROSION.**
- **OPPORTUNITY TO REVIEW THE PRODUCT'S ORIGINAL CONDITION. INSPECTION OF YOUR PRODUCT UPON POSSESSION OR DELIVERY IS YOUR ONLY.**

Damage resulting from installation or transportation is not Precision's responsibility. Installation and/or transportation of this product releases Precision from any liability for surface scratches, dents, warping, jamb misalignment, frame gaps, or any other structural problems of such nature that can be caused during the installation and/or transportation, and are not the responsibility of Precision. Contact your installer or transporter directly, if applicable, for resolution. Products such as steel security doors can make noise from component rattling when closed. This is not a warranty issue. Chemicals may react to paint finishes and cause discoloration. This is not under warranty. This warranty expressly excludes the screen mesh and mesh components, which include rips, tears, separation, fraying, snags in or on screen material, or the detaching of the screen material from the spline channel. Specific warranty periods may vary based on door model and color configuration (see below); please refer to the information provided on your door model or inquire for further details.

### Warranty Period Product Guide

Black, White, Bronze, Almond, Adobe, Weathered Brown ..... 1 Year from the purchase date  
 Economy Doors ..... 90 Days from the purchase date

If you have a warranty claim please notify Precision Screen and Security Doors and have the following information available:

Door Model Number: \_\_\_\_\_  
 Dated Proof of Purchase Receipt \_\_\_\_\_  
 Name of Installer (if installed by other than homeowner) \_\_\_\_\_  
 Detailed explanation of the defect (photos may be requested by Precision) \_\_\_\_\_  
 \_\_\_\_\_

# We're Serious About QUALITY

Precision Screen & Security Products  
supplies a quality inspection sticker  
on every door we make.

## PRECISION "SAFEGUARD" PACKAGING

We take special measures to assure your products are protected during delivery to your business and packaged to stand up to the loading and reloading that is common to our industry. We know as you prepare for delivery to your customer, that you need the product to be as protected as possible. We take pride in being unique to the industry in this regard.

❖ Hardware pack securely packaged.



❖ Completely shrink-wrapped for protection.

❖ Protected Corners

## COLOR SELECTIONS

Precision Deluxe Powder Coat

Semi-Gloss Finish

Steel Only

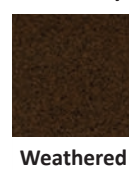
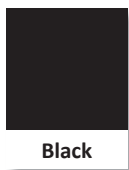

Note: The colors shown are only representations of color selections  
Please refer to Color Key Samples in order to guarantee exact match

- Not all selections available in every door style. See individual door pages.





# DID YOU — KNOW —

Precision makes custom steel products for commercial and residential use

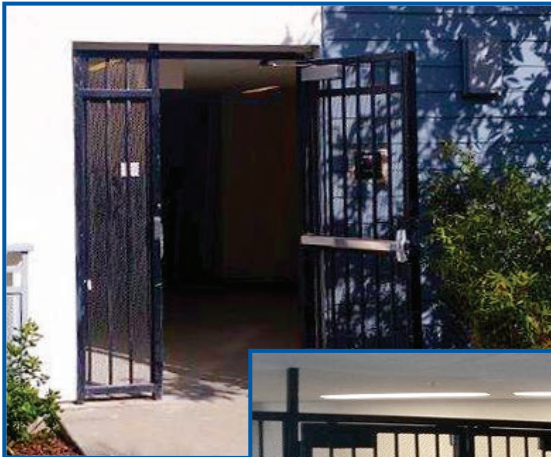

- Security gates
- Fencing
- Garage entry barriers
- Rolling gates up to 30 ft. long
- Perimeter controlled access (to fit any opening)
- Frame sizes up to 2 in. x 6 in. available (6 in. x 6 in. posts)

Let our commercial division bid on your next project.  
Call our design specialist to discuss your project needs.

# SECTION 1 / SWINGING SCREEN DOORS

PRODUCT	PAGE
Extruded aluminum security & deluxe screen doors.....	2 - 9
Economy roll form screen doors.....	10
Custom options .....	11
Handle hardware - standard & upgrade .....	12
Double door astragal kits.....	13
Bottom & side adjustment channels .....	14
Worksheet & sizing chart .....	15
Order form .....	16

## STEEL & EXTRUDED ALUMINUM SCREEN DOORS

This section includes an example and specifications on Precision’s line of extruded aluminum screen and extruded aluminum security screen doors. These products are manufactured in the U.S.A.

All Precision aluminum screen and security screen doors have a 1 (one) year warranty on workmanship and material (see terms and conditions page for details.)

The pictures shown illustrate some of the finish options available. Standard finishes are indicated on each page. See our Precision color selections page.

Standard sizes shown are “call-out” sizes. The actual “standard” net frame size is indicated in this chart.

### STANDARD INCH (in.) NET FRAME SIZE

#### Extruded aluminum security door:

Centurion, .....29-1/4 in., 31-1/4 in. & 35-1/4 in. x 79-1/2 in.

#### Extruded aluminum swinging door:

Brighton, Clearview, Colonade, Fiesta,  
Safeguard, Santa Cruz, Santa Cruz Full Grille.....29-1/4 in., 31-1/4 in. & 35-1/4 in. x 79-1/4 in.

#### Roll form swinging steel door:

Provencial..... 31-1/8 in. & 35-1/8 in. x 79-3/4 in.

The net overall frame size is the door without hinge/bottom adjustment channels.

See pages at the end of this section for information regarding the custom order sizes, prices and options available on Precision aluminum doors.

For any questions regarding any Precision products or specifications, please contact your sales representative or call Precision order desk.



### Product Line - D3002

#### Extruded Aluminum Screen Door

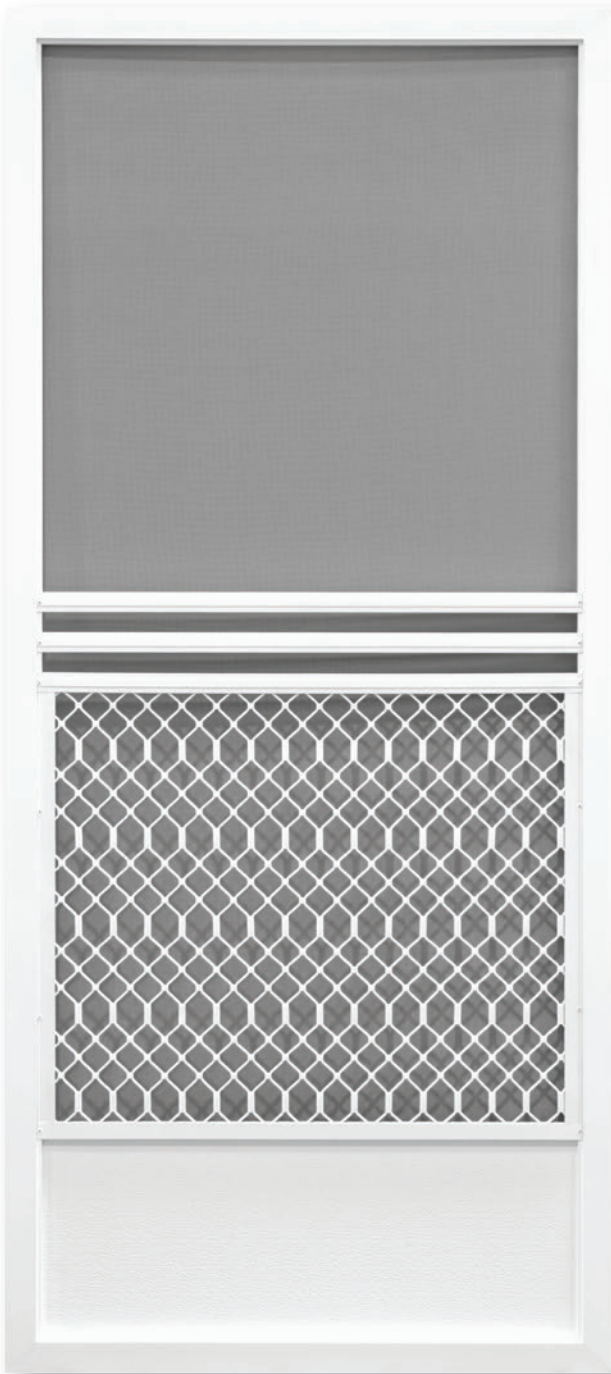

#### Features

- 2-1/8 in. x 3/4 in. .050 Extruded aluminum frame
- Standard 12 in. embossed .024 aluminum kickplate
- Standard sizes  
2'6 in. x 6'8 in. (29-1/4 in. x 79-1/4 in.)  
2'8 in. x 6'8 in. (31-1/4 in. x 79-1/4 in.)  
3'0 in. x 6'8 in. (35-1/4 in. x 79-1/4 in.)
- Custom widths 24 in. up to 41-1/4 in., heights up to 110 in.  
**Extra charges will apply for doors over 96 in. in height**
- Charcoal fiberglass insect screening
- Standard push button handle
- 1-7/8 in. .050 side adjustable channel  
3 hinges
- 1-7/8 in. .050 bottom adjustment channel
- Extruded amplimesh 3/16 in. aluminum grille

#### Standard Finishes

- Adobe, almond, black, bronze or white powder coated
- Satin and bronze anodized



Standard push button latch with touch and go closer included. See page 12 for finishes.

#### Options Available

yes	9 in. kick plate	yes	Pet door
yes	Custom sizes	yes	Pre-Hung kit
yes	Double door astragal	yes	Push bar
yes	Handle color options	yes	Cloth upgrade

Extruded Aluminum  
Screen Door



## Features

- 2-1/8 in. x 3/4 in. .050 Extruded aluminum frame
- Standard 6 in. embossed .024 aluminum kickplate (8-1/8 in. overall)
- Standard sizes  
2'6 in. x 6'8 in. (29-1/4 in. x 79-1/4 in.)  
2'8 in. x 6'8 in. (31-1/4 in. x 79-1/4 in.)  
3'0 in. x 6'8 in. (35-1/4 in. x 79-1/4 in.)
- Custom widths 29 in. up to 47-7/8 in., heights up to 110 in.  
**Extra charges will apply for doors over 96 in. in height**
- Charcoal fiberglass insect screening
- Standard push button handle
- 1-7/8 in. .050 channel side adjustable 3 hinges
- 1-7/8 in. .050 bottom adjustment channel

## Standard Finishes

- Adobe, almond, black, bronze or white powder coated
- Bronze or satin anodized

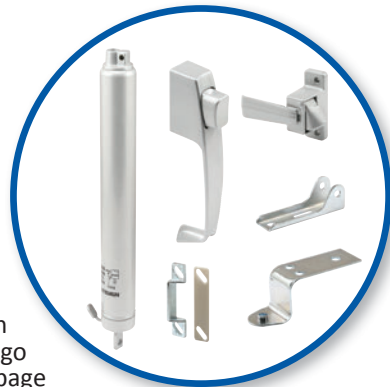

Standard push button latch with touch and go closer included. See page 12 for finishes.

## Options Available

yes	9 in. kick plate	yes	Pet door
yes	Custom sizes	yes	Pre-Hung kit
yes	Double door astragal	yes	Push bar
yes	Handle color options	yes	Cloth upgrade





Product Line - D3002

Extruded Aluminum  
Screen Door

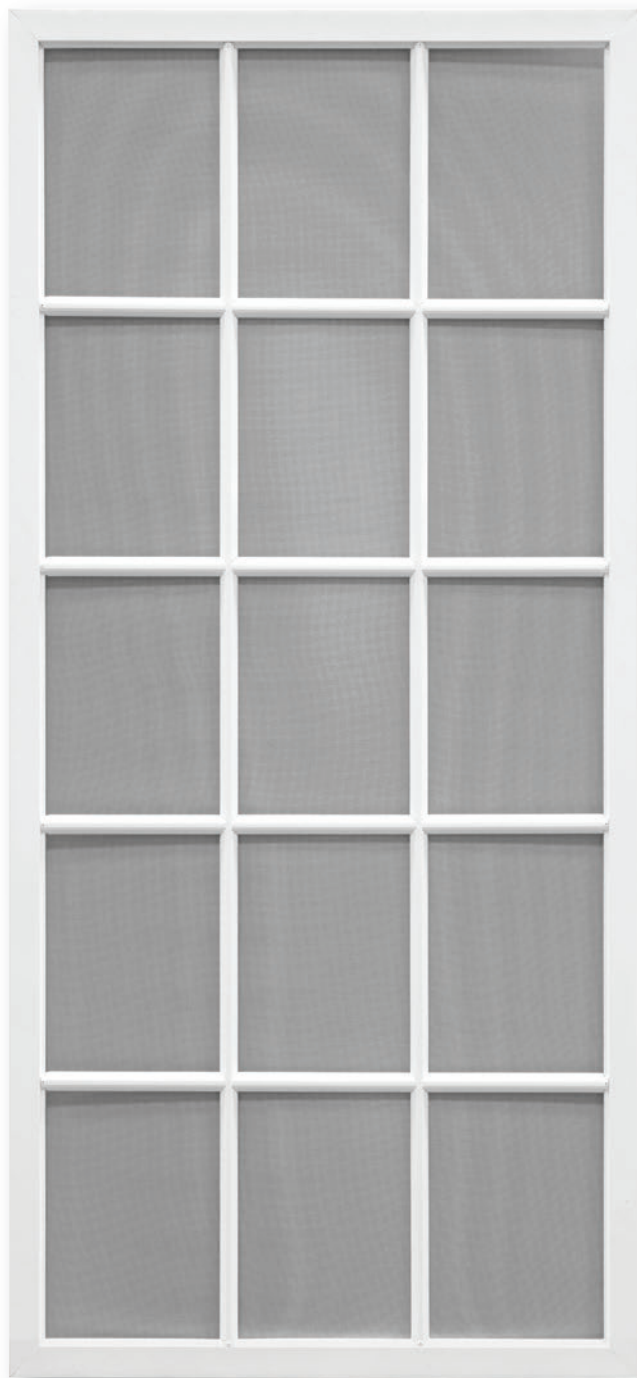

### Features

- 2-1/8 in. x 3/4 in. .050 Extruded aluminum frame
- Standard sizes  
2'6 in. x 6'8 in. (29-1/4 in. x 79-1/4 in.)  
2'8 in. x 6'8 in. (31-1/4 in. x 79-1/4 in.)  
3'0 in. x 6'8 in. (35-1/4 in. x 79-1/4 in.)
- Custom widths 29 in. up to 47-7/8 in., heights up to 110 in.

***Extra charges will apply for doors over 96" in height***

- 1 in. wide sculptured 15 lite grid pattern
- Charcoal fiberglass insect screening
- Standard push button handle
- 1-7/8 in. .050 side adjustable channel  
3 hinges
- 1-7/8 in. .050 bottom adjustment channel

### Standard Finishes

- Adobe, almond, black, bronze or white powder coated



Colonade shown with optional kick plate (options shown have additional cost)



### Options Available

yes	9 in. kick plate	yes	Pet door
yes	Custom sizes	yes	Pre-Hung kit
yes	Double door astragal	⊘	Push bar
yes	Handle color options	yes	Cloth upgrade

Extruded Aluminum  
Screen Door

**Features**

- 2-1/8 in. x 3/4 in. .050 Extruded aluminum frame
- Standard 12 in. embossed .024 aluminum kickplate
- Standard sizes only - **No custom sizes**  
2'6 in. x 6'8 in. (29-1/4 in. x 79-1/4 in.)  
2'8 in. x 6'8 in. (31-1/4 in. x 79-1/4 in.)  
3'0 in. x 6'8 in. (35-1/4 in. x 79-1/4 in.)
- Charcoal fiberglass insect screening
- Standard push button handle
- 1-7/8 in. .050 side adjustment channel  
3 hinges
- 1-7/8 in. .050 bottom adjustment channel
- Extruded amplimesh 3/16 in. aluminum grille

**Standard Finishes**

- Adobe, almond, bronze or white powder coated
- Satin anodized



Standard push button latch with touch and go closer included. See page 12 for finishes.

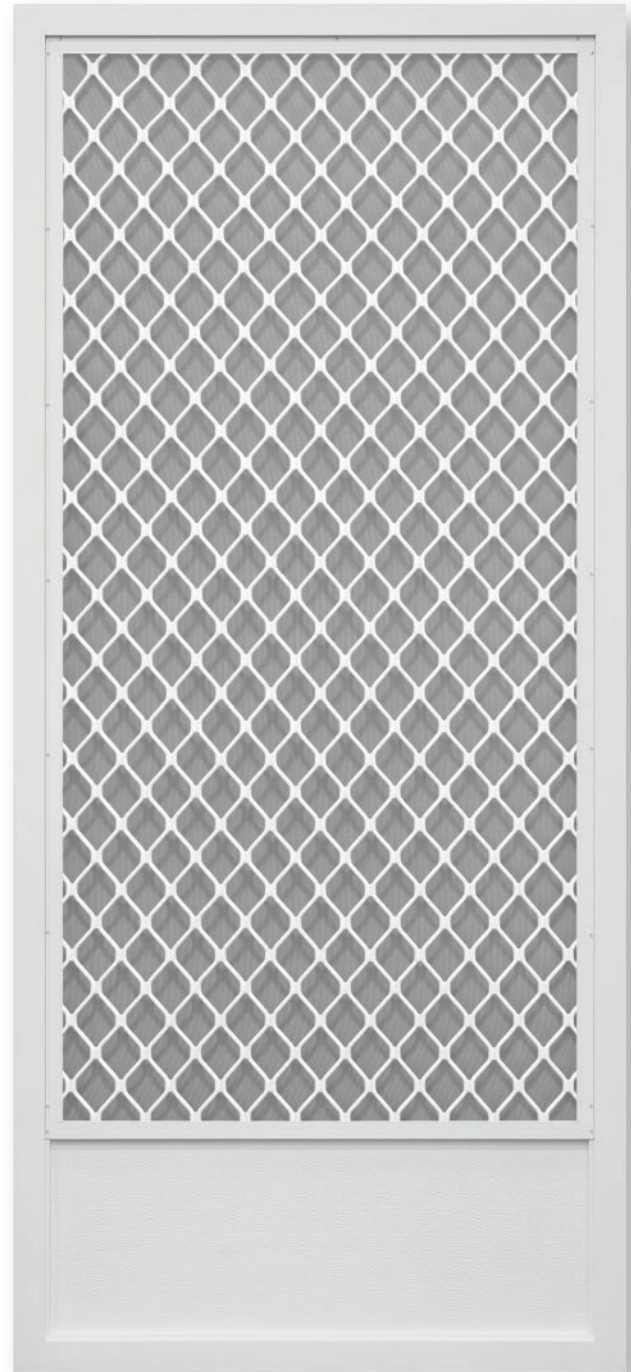

*Options Available*

- |   |  |
|---|--|
| <input type="checkbox"/> 9 in. kick plate     | <input type="checkbox"/> Pet door      |
| <input type="checkbox"/> Custom sizes         | <input type="checkbox"/> Pre-Hung kit  |
| <input type="checkbox"/> Double door astragal | <input type="checkbox"/> Push bar      |
| <input type="checkbox"/> Handle color options | <input type="checkbox"/> Cloth upgrade |

## Product Line - D3002

### Extruded Aluminum Screen Door

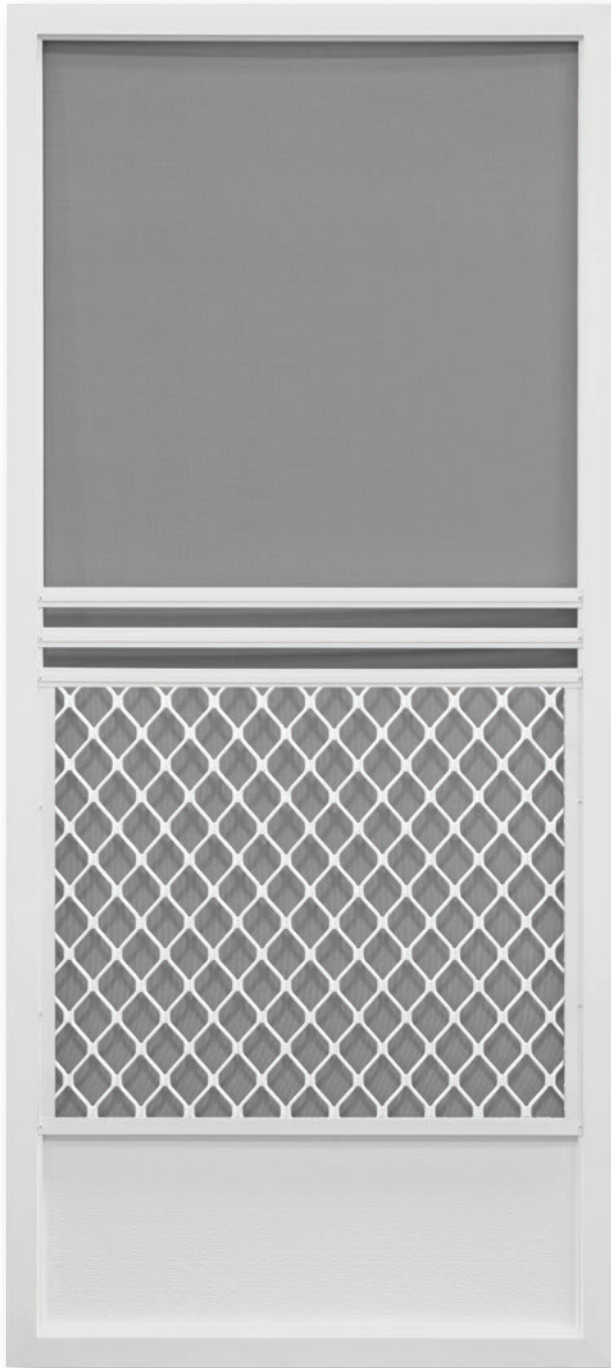

### Features

- 2-1/8 in. x 3/4 in. .050 Extruded aluminum frame
- Standard 12 in. embossed .024 aluminum kickplate
- Standard sizes  
2'6 in. x 6'8 in. (29-1/4 in. x 79-1/4 in.)  
2'8 in. x 6'8 in. (31-1/4 in. x 79-1/4 in.)  
3'0 in. x 6'8 in. (35-1/4 in. x 79-1/4 in.)
- Custom widths 24 in. up to 41-1/4 in., heights up to 110 in.

***Extra charges will apply for doors over 96" in height***

Charcoal fiberglass insect screening

- Standard push button handle
- 1-7/8 in. .050 side adjustable channel  
3 hinges
- 1-7/8 in. .050 bottom adjustment channel
- Extruded amplimesh 3/16 in. aluminum grille

### Standard Finishes

- Adobe, almond, bronze or white powder coated
- Satin anodized



Standard push button latch with touch and go closer included. See page 12 for finishes.

### Options Available

yes	9 in. kick plate	yes	Pet door
yes	Custom sizes	yes	Pre-Hung kit
yes	Double door astragal	⊘	Push bar
yes	Handle color options	yes	Cloth upgrade



## Features

- 2-1/8 in. x 3/4 in. .050 Extruded aluminum frame, adjusts up to 1 in. wide and 1-3/4 in. high
- Standard 12 in. embossed .024 aluminum kickplate
- Standard sizes  
2'6 in. x 6'8 in. (29-1/4 in. x 79-1/4 in.)  
2'8 in. x 6'8 in. (31-1/4 in. x 79-1/4 in.)  
3'0 in. x 6'8 in. (35-1/4 in. x 79-1/4 in.)
- Custom widths 24 in. up to 47-7/8 in., heights up to 110 in.  
**Extra charges will apply for doors over 96" in height**
- Charcoal fiberglass insect screening
- Standard push button handle
- 1-7/8 in. .050 side adjustment channel  
3 hinges
- 1-7/8 in. .050 bottom adjustment channel
- Standard Fiesta expanded aluminum grille

## Standard Finishes

- Adobe, almond, black, bronze or white powder coated
- Bronze or satin anodized
- Mill



Fiesta with pet door installed  
(options shown have additional cost)

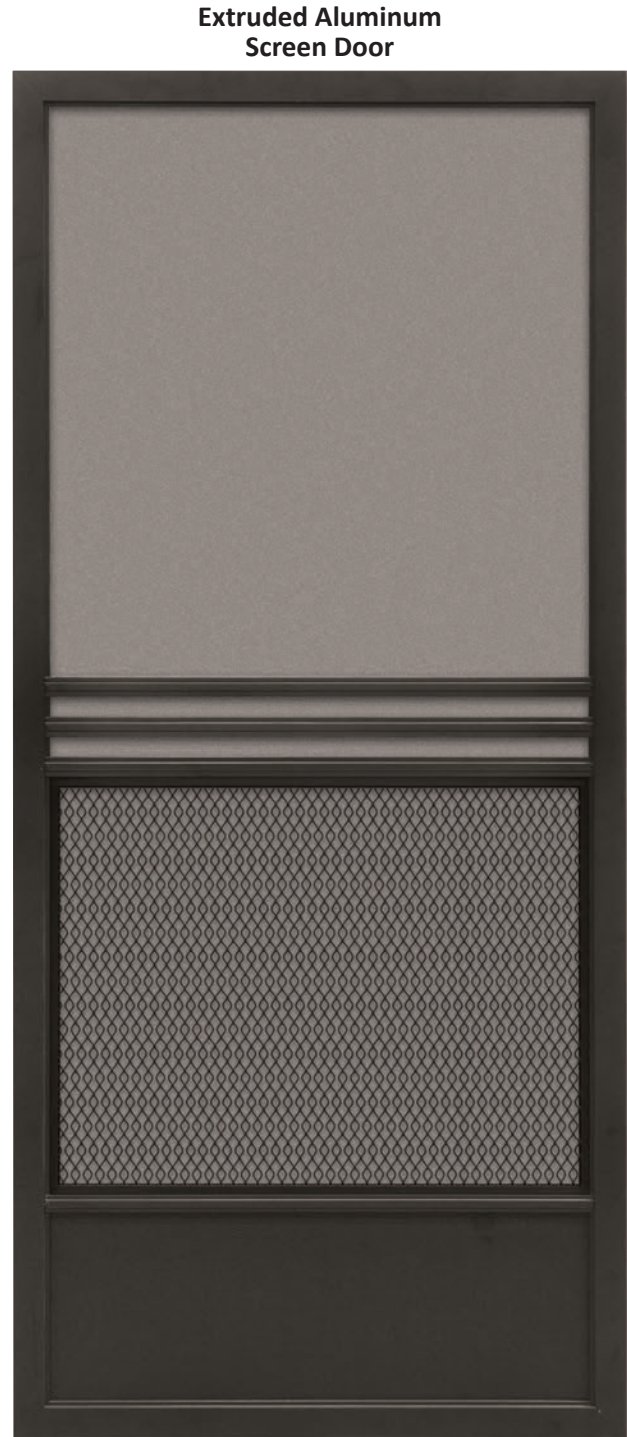

## Options Available

yes	9 in. kick plate	yes	Pet door
yes	Custom sizes	yes	Pre-Hung kit
yes	Double door astragal	yes	Push bar
yes	Handle color options	yes	Cloth upgrade

Product Line - D3002

Extruded Aluminum  
Screen Door

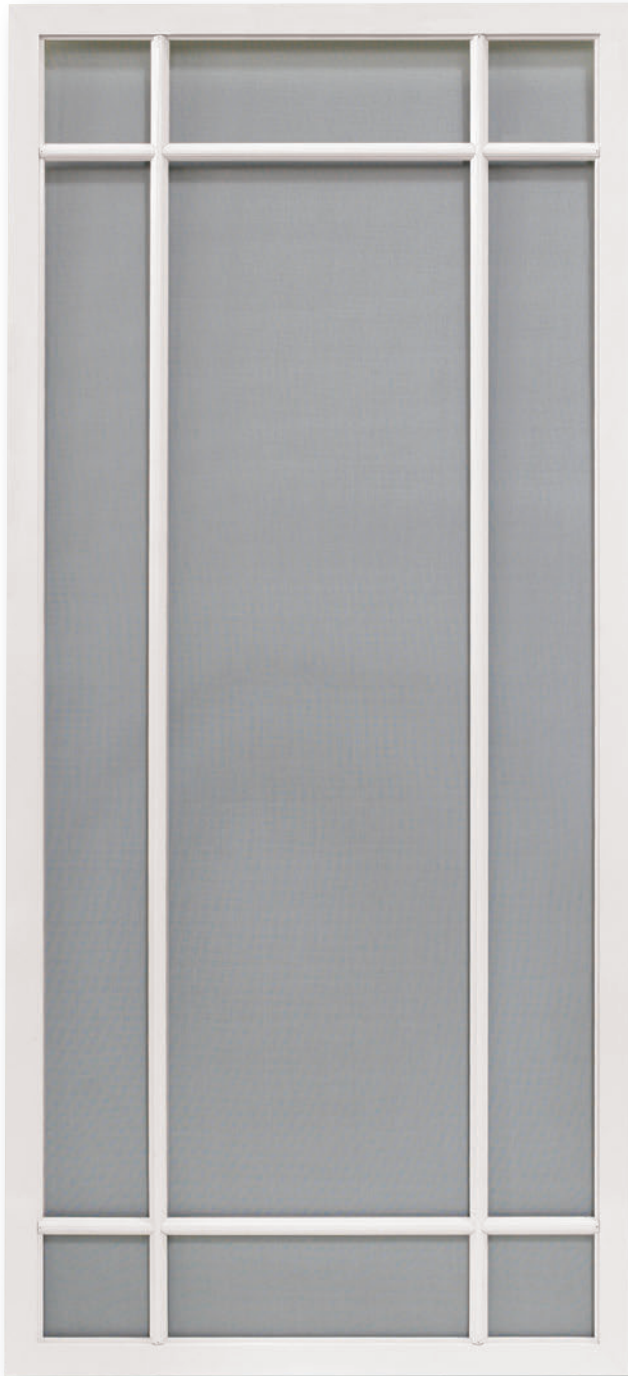

### Features

- 2-1/8 in. x 3/4 in. .050 Extruded aluminum frame
- Standard sizes  
2'6 in. x 6'8 in. (29-1/4 in. x 79-1/4 in.)  
2'8 in. x 6'8 in. (31-1/4 in. x 79-1/4 in.)  
3'0 in. x 6'8 in. (35-1/4 in. x 79-1/4 in.)
- Custom widths 24 in. up to 47-7/8 in., heights up to 110 in.  
Extra charges will apply for doors over 96 in. in height
- 1 in. wide sculptured 9 lite marginal grid pattern
- Charcoal fiberglass insect screening
- Standard push button handle
- 1-7/8 in. .050 side adjustable channel  
3 hinges
- 1-7/8 in. .050 bottom adjustment channel

### Standard Finishes

- Adobe, almond, black, bronze or white powder coated



Standard push button latch with touch and go closer included. See page 12 for finishes.



### Options Available

yes	9 in. kick plate	yes	Pet door
yes	Custom sizes	yes	Pre-Hung kit
yes	Double door astragal	⊘	Push bar
yes	Handle color options	yes	Cloth upgrade

## Features

- NEW, STRONGER 3 in. x 1 in. .062 Extruded Aluminum Frame.
- Solid Aluminum Spur Corners  
(4) Screws per Corner for Increased Security
- Extruded Amplimesh 1/4 in. Aluminum Centurion Grille
- 1-1/2 in. .050 Side Adjustable Channel with (3) Hinges
- 1-1/2 in. .050 Bottom Adjustment Channel
- Charcoal Fiberglass Insect Screening
- Heavy Duty Closer Included
- Solid Brass, Black Powder Coated Double Throw Deadbolt Assembly w/ Thumb Turn & Key Lock
- Thick Acrylic Lock Surround for Added Security
- Standard Sizes  
2'6 in. x 6'8 in. (29-1/4 in. x 79-1/2 in.)  
2'8 in. x 6'8 in. (31-1/4 in. x 79-1/2 in.)  
3'0 in. x 6'8 in. (35-1/4 in. x 79-1/2 in.)
- Custom Widths 24 in. up to 41-3/4 in., Heights up to 97-1/8 in.

### Must Specify Handing

## Standard Finishes

- Adobe, Almond, Bronze or White Powder Coated
- Bronze Anodized



Deadbolt Latch Assembly Included.

Extruded Aluminum Security Screen Door



## Options Available

- |   |                                   |
|---|-----------------------------------|
| <input type="checkbox"/> 9 in. kick plate     | <input type="checkbox"/> Pet door |
| yes Custom sizes                              | yes Pre-Hung kit                  |
| <input type="checkbox"/> Double door astragal | <input type="checkbox"/> Push bar |
| <input type="checkbox"/> Handle color options | yes Cloth upgrade                 |





## Economy Roll Form Steel

### Features

- 2 in. x 7/8 in. .016 Roll form steel frame
- Standard 5-1/4 in. kickplate
- Standard sizes only - **No custom sizes**  
2'8 in. x 6'8 in. (31-1/4 in. x 79-3/4 in.)  
3'0 in. x 6'8 in. (35-1/4 in. x 79-3/4 in.)
- Charcoal fiberglass insect screening
- Single push bar
- Standard push button handle
- 1 in. bottom channel adjustment for proper height adjustment

### Standard Finishes

Bronze, Gray or White

**Only sold in Packs of (4). Not sold individually.**

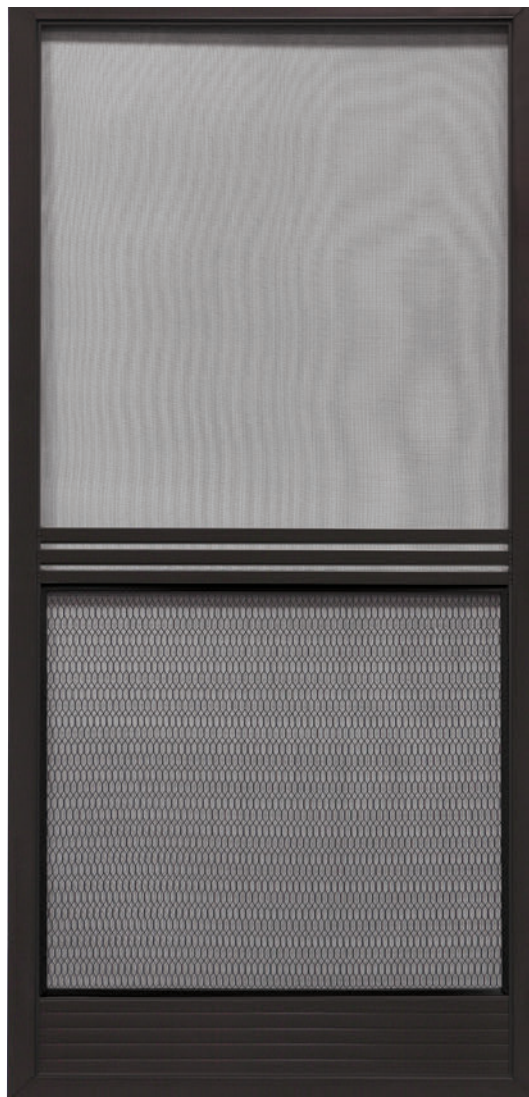

# SCREEN DOOR ACCESSORIES

Standard and deluxe series door hardware



## DESIGNER HARDWARE

Standard lever handle for our .062 in. aluminum extruded deluxe security doors

Finish	Part No.	Product Line
Black	2964BK	F3970

**Includes:** Inside and outside lever assembly, mortise lock, key cylinder, spindle, strike box, strike plate, screws and installation instructions.

The Designer hardware pack does not include a closer, but a standard hardware pack is included automatically with every swinging door purchase at no extra charge.



## STANDARD HARDWARE KIT PACK

For .050 in. extruded and roll form screen doors

Finish	Part No.	Product Line
Adobe	2090AD	F3320
Almond	2090AL	F3320
Black	2090BK	F3320
Bronze	2090BZ	F3320
Silver	2090SL	F3320
White	2090WH	F3320



Hardware Kit

**Note:** Color coordinated hardware pack is automatically included with screen door purchase.

**Includes:** Push button handle, inside latch, touch and go closer, bracket, screws and installation instructions.

See pages 11-14 for all available options choices.

**Note:** Not all options are available in every door style, see individual door pages for specific information.

# HINGED SCREEN DOOR

Custom options (add-ons) for extruded aluminum doors

Product Line D9999 for all options on this page

Option	Option Code	Description
<b>Frame</b>	OP-1PB-1	Install 1 each #288PB – 1-1/8 in. Extruded push bar
	OP-1PB-2	Install 2 each #288PB – 1-1/8 in. Extruded push bars
	OP-1PB-3	Install 3 each #288PB – 1-1/8 in. Extruded push bars
	OP-ADDKPLATE-9	Install a 9 in. kickplate in place of stock kickplate
	OP-ADDKPLATE-12	Install a 12 in. kickplate in place of stock kickplate
	OP-ADDKPLATE-20	Install a 20 in. kickplate in place of stock kickplate
	OP-SWSLOT4HNDL	Special placement security door lock (Centurion only)
<b>Handle</b>	2964xx	Add new designer hardware (extruded doors only)
<b>Hinge</b>	OP-ADDHINGE-1	Additional hinge to channel (special hinge placement on channel)
<b>Pre-hung frame for aluminum doors</b>	OP-PREHUNG	Available pre-installed on door only (available in satin, white, bronze, almond, adobe, & black)
<b>Pet door</b>	OP-PD-SWG-S	Install pet door centered – small
	OP-PD-SWG-M	Install pet door centered – medium
	OP-PD-SWG-L	Install pet door centered – large
	OP-PD-SWG-X	Install pet door centered – extra large
<b>Screen cloth</b>	OP-SC14CF	Charcoal fiber 18 in. x 14 in.
	OP-SC14GF	Gray fiber 18 in. x 14 in.
	OP-SC16BA	Brite aluminum 18 in. x 16 in.
	OP-SC16BV	Better view
	OP-SC16CF	Charcoal fiber 18 in. x 16 in. (Standard)
	OP-SC16GF	Gray fiber 18 in. x 16 in.
	OP-SCD	Delete screen cloth & spline, Door shell only
	OP-SCPSBK	Black petscreen
	OP-SCPSLBK	Black petscreen lite
	OP-SCSTBK	Black sun tex - 80%
	OP-SCSTGR	Gray sun tex - 80%
	OP-SCSTST	Stucco sun tex - 80%

*See price list for additional OP in. options*



# SCREEN DOOR ACCESSORIES

Double door kits

## ONE-PIECE SCREEN DOOR ASTRAGAL

Slide Bolt - 2891BK - Spring not included

Spring - 2891-S

**Fits our extruded series screen doors only**

(Does not work with any other door in our line)

For ease of installation and enhanced visual appearance. Precision has designed a double door astragal system for screen doors.

- Slide bolts are self contained and hidden from view. (Internal slide bolt 2891, 2891-S)
- Simple installation
- No unsightly slide bolts to install separately.
- Easy for the installer

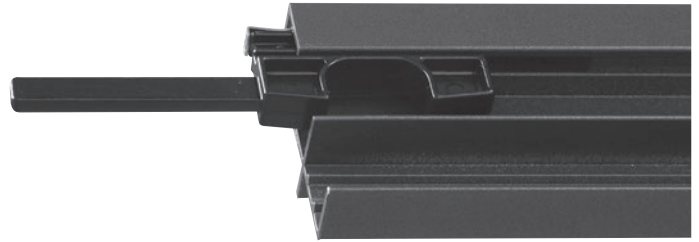

Finish	Product Line	Product Line	
		Size - (84 in.)	Size - (96 in.)
Adobe	F3950	2920AD	2921AD
Almond	F3950	2920AL	2921AL
Black	F3950	2920BK	2921BK
Bronze	F3950	2920BZ	2921BZ
Bronze anodized	F3950	2920BA	2921BA
Satin anodized	F3950	2920SA	2921SA
White	F3950	2920WH	2921WH



# SCREEN DOOR ACCESSORIES

Bottom adjustment & hinge adjustment channels

**B.A.C.**= Bottom Adjustment Channel  
**H.S.A.C.**= Hinge Side Adjustment Channel (comes standard with 3 hinges)

Finish	Product Line	Bottom channel 36 in. (BAC)	Hinge channel (HSAC) 81 in.	96 in.
--------	--------------	--------------------------------	--------------------------------	--------

## Extruded Aluminum Doors

Adobe	F3320	2036AD	2041AD	2076AD
Almond	F3320	2036AL	2041AL	2076AL
Black	F3320	2036BK	2041BK	2076BK
Bronze	F3320	2036BZ	2041BZ	2076BZ
Bronze Anodized	F3320	2036BA	2041BA	2076BA
Satin Anodized	F3320	2036SA	2041SA	2076SA
White	F3320	2036WH	2041WH	2076WH

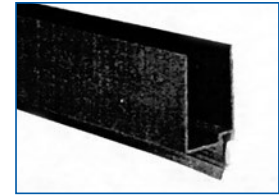

Extruded aluminum bottom adjustment channel with sweep

## Extruded Aluminum Security Doors

Bronze	F3970	2946BZ	2953BZ
White	F3970	2946WH	2953WH

<b>Black Vinyl Sweep</b>	F3320	2975BK-750
--------------------------	-------	------------

## Screen Door Hinge

Adobe	F3850	2175AD
Almond	F3850	2175AL
Bronze	F3850	2175BZ
White	F3850	2175WH

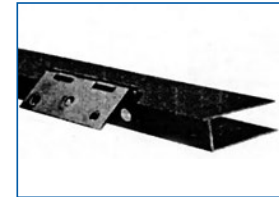

Extruded aluminum hinge side adjustment channel

## DOUBLE SCREEN DOOR KITS

Fits all extruded & roll form screen doors

Finish	Product Line	Size - (84 in.)	Size - (96 in.)
Adobe	F3950	2911AD-84	2912AD-96
Almond	F3950	2911AL-84	2912AL-96
Black	F3950	2911BK-84	2912BK-96
Bronze	F3950	2911BZ-84	2912BZ-96
Bronze anodized	F3950	2911BA-84	2912BA-96
Satin anodized	F3950	2911SA-84	2912SA-96
White	F3950	2911WH-84	2912WH-96

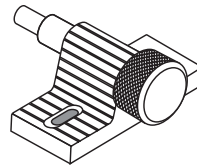

Slide bolt



Strike

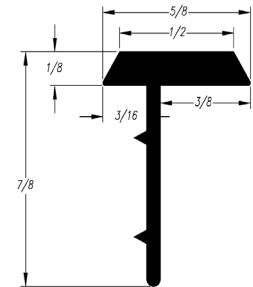

Actual size

### Kit Includes:

- 1 Extruded astragal with screws
- 1 Special strike with shim
- 2 #2890 Slide-bolts (black only)
- 1 Instruction sheet

## DOUBLE SECURITY SCREEN DOOR KITS

Fits Centurion

Finish	Product Line	Size - (84 in.)	Size - (96 in.)
Bronze	F3950	2976BZ-84	2981BZ-96
White	F3950	2976WH-84	2981WH-96

### Kit Includes:

- 1 Extruded astragal with screws
- 1 Double door strike plate (brass)
- 2 #2890 Slide-bolts (black only)
- 1 Instruction sheet

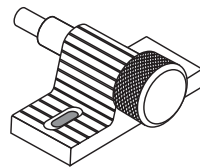

Slide bolt

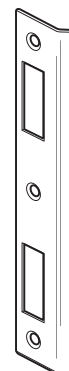

French door strike plate

### For Security Doors

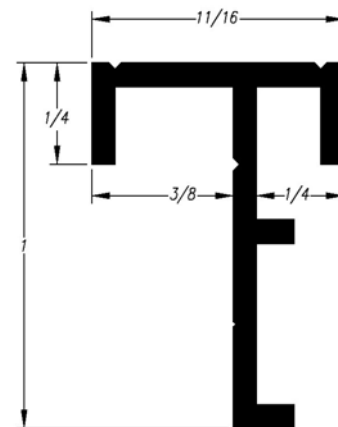

Security door "T" - astragal

# SWINGING SCREEN DOOR WORKSHEET

Use this worksheet to help your customer in measuring and selecting their door

Phone (909) 379-0123

Customer Name \_\_\_\_\_

Job Name/PO# \_\_\_\_\_

## Step 1

- Width Always First
- Measure opening width, inside jamb to inside jamb at three places (top, middle & bottom)
- Always in inches
- Always outside house looking in
- Take the largest of the three measurements

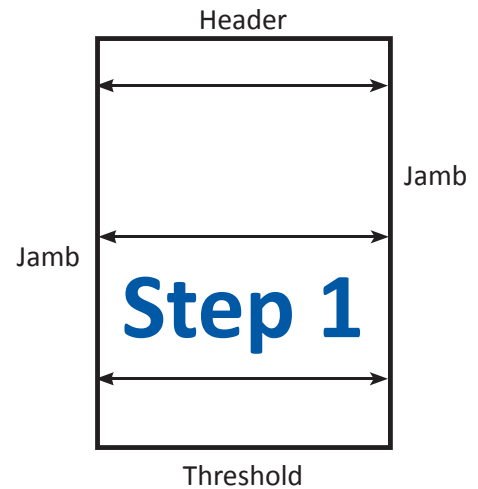

## Step 2

- Measure opening height from threshold to header (inside to inside)
- Always in inches
- Always outside looking in

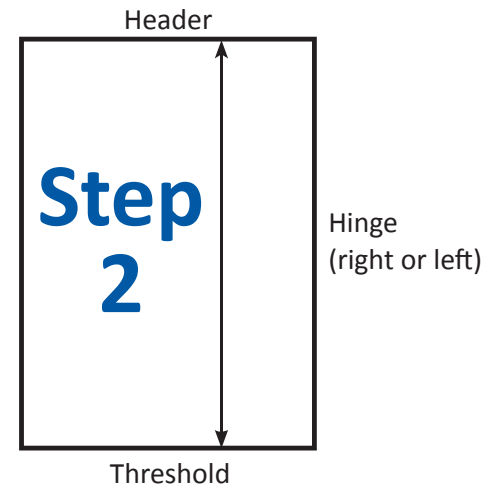

## Step 3

- Measured Width \_\_\_\_\_ - 3/4 in. = \_\_\_\_\_ Net Size
- Measured Height \_\_\_\_\_ - 3/4 in. = \_\_\_\_\_ Net Size

## Step 4

- Select Door, Color and Options
- If Pre-Hung frame needed specify hinge side (Right or Left) *(from outside looking in)*

# DOOR SIZING CHART

Aluminum and Heavy Duty Steel Swinging Screen Doors

Door Series		DOOR WIDTH			NET DOOR HEIGHT		
		Net door width	With hinge channel collapsed	With hinge channel extended	Without bottom channel	With bottom channel collapsed	With bottom channel extended
Aluminum Security Door <i>Centurion</i>	(36 in.) 3/0=	35-1/4 in.	35-1/2 in.	36-1/4 in.	79-1/2 in.	79-3/4 in.	80-3/4 in.
	(32 in.) 2/8=	31-1/4 in.	31-1/2 in.	32-1/4 in.	79-1/2 in.	79-3/4 in.	80-3/4 in.
	(30 in.) 2/6=	29-1/4 in.	29-1/2 in.	30-1/4 in.	79-1/2 in.	79-3/4 in.	80-3/4 in.
Extruded Aluminum <i>Brighton, Fiesta, Safeguard, Santa Cruz, Santa Cruz Full Grille, Colnade, Clearview</i>	(36 in.) 3/0=	35-1/4 in.	35-1/2 in.	36-1/2 in.	79-1/4 in.	79-1/2 in.	80-5/8 in.
	(32 in.) 2/8=	31-1/4 in.	31-1/2 in.	32-1/2 in.	79-1/4 in.	79-1/2 in.	80-5/8 in.
	(30 in.) 2/6=	29-1/4 in.	29-1/2 in.	30-1/2 in.	79-1/4 in.	79-1/2 in.	80-5/8 in.
Roll Form Steel <i>Provincial</i>	(36 in.) 3/0=	35-1/8 in.	35-1/2 in.	36-3/8 in.	79-3/4 in.	79-3/4 in.	81 in.
	(32 in.) 2/8=	31-1/8 in.	31-1/2 in.	32-3/8 in.	79-3/4 in.	79-3/4 in.	81 in.





# SECTION 2 / DOMESTIC STEEL SECURITY DOORS

PRODUCT	PAGE
Water jet steel security doors .....	22-25
Steel security doors .....	26-44
Steel security door custom options.....	45
Vineyard, Paradise, Impressions & Longevity door inserts.....	46
Steel patio door & enclosure.....	47-51
Steel patio door & enclosure options.....	52
Steel window guards .....	53-54
Steel window guard accessories.....	55
Steel security door mounting variations .....	56
Worksheet .....	57-59
Steel security door short worksheet .....	60

## COLOR SELECTIONS

### Precision Deluxe Powder Coat

#### Semi-Gloss Finish

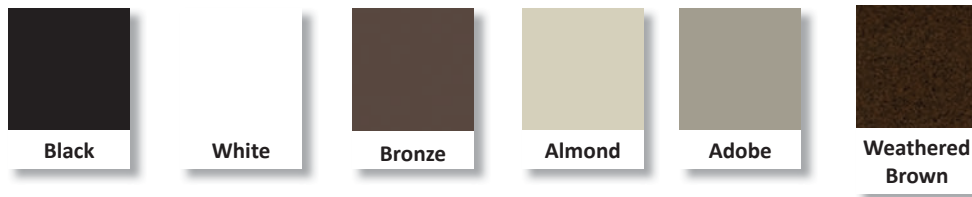

#### \*\*NEW\*\* Textured Finishes

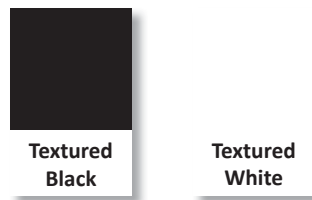

Note: The colors shown are only representations of color selections  
Please refer to Color Key Samples in order to guarantee exact match

# DOMESTIC STEEL SECURITY DOORS

This section includes photographs and specifications of Precision's line of steel security products. These products are manufactured in the U.S.A. All items are welded, assembled and finished using high quality raw materials and state of the art equipment. For a complete catalog of Precision products, or if you have any question regarding any Precision products or specifications, please contact your Precision representative or call Precision customer service.

Refer to the "Terms and Conditions" page for warranty information.

The pictures shown may illustrate optional finishes. Standard finishes & sizes for each item are shown on the products corresponding page.

Precision steel security doors come standard as surface mount. Refer to page 56 for mounting variations.

The standard sizes indicated in this section represent "industry standard" door openings.

**Refer to the order forms on pages 57-60.**

Steel security door dimensions:

A. The net overall size, which includes a 1-1/4 in. sq. 3-piece surface mounted frame, is as follows:

Door Opening	Net Overall Size
2'6 in. x 6'8 in. (30 in. x 80 in.)	2'9 in. x 6'9-3/4 in. (33 in. x 81-3/4 in.)
2'8 in. x 6'8 in. (32 in. x 80 in.)	2'11 in. x 6'9-3/4 in. (35 in. x 81-3/4 in.)
3'0 in. x 6'8 in. (36 in. x 80 in.)	3'3 in. x 6'9-3/4 in. (39 in. x 81-3/4 in.)

B. When ordering surface mounted, custom size steel security doors: add 3 in. to the opening width & 1-3/4 in. to the opening height

C. Standard perforated metal is 24 gauge and is attached to the steel tube frame with stainless steel rivets.

Steel Master - 3812, Italian Leaf - 3824, English Ivy - 3829, Sonoma - 3830 dimensions:

A. The Net Overall Size, which includes a 1-1/2 in. sq. 1-piece, 3-sided surface mounted frame, is as follows:

Door Opening	Net Overall Size
2'6 in. x 6'8 in. (30 in. x 80 in.)	2'9-1/2 in. x 6'10 in. (33-1/2 in. x 82 in.)
2'8 in. x 6'8 in. (32 in. x 80 in.)	2'11-1/2 in. x 6'10 in. (35-1/2 in. x 82 in.)
3'0 in. x 6'8 in. (36 in. x 80 in.)	3'3-1/2 in. x 6'10 in. (39-1/2 in. x 82 in.)

B. When ordering surface mounted, custom size Steel Masters: add 3 1/2 in. to the opening width & 2 in. to the opening height

C. Standard perforated metal is 24 gauge and is attached to the steel tube frame with stainless steel rivets.

Refer to page 45 for options.

Custom doors require a (5 to 6) week lead time on average.

A signed confirmation must be received by Precision before any custom items are scheduled for production. Precision is not responsible for any errors and/or omissions in customer verified information.

**On products with perforated metal that is welded in place on special request, the perforated metal may experience deformation and the item may have areas of insufficient finish.**

**To prevent oxidation (rust), touch up any scratches, chips, etc. with a quality rust inhibiting paint as soon as possible. In order to maintain a rust free finish, regularly inspect and re-paint as needed. In exposed, damp or coastal areas annual painting is recommended.**



# NEW STEEL MESH OPTIONS



- Offers increased airflow
- Improves visibility
- Removable screen mesh for easy replacement

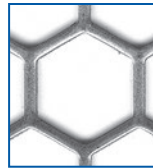

*Actual size*

## **OP-HEXPERFSCREEN16 (Shown)**

16 gauge hex perf option with screen  
Up to 46 in. x 96 in.  
79% Open area



Each door includes a screen panel with 18-16 charcoal screen mesh.

**MADE IN THE  
USA** 



# NEW STEEL MESH OPTIONS

- Offers increased airflow
- Improves visibility
- Removable screen mesh for easy replacement



Actual size

## OP-HEXPERFSCREEN22

22 gauge hex perf option with screen

Up to 48 in. x 84 in.

79% Open area

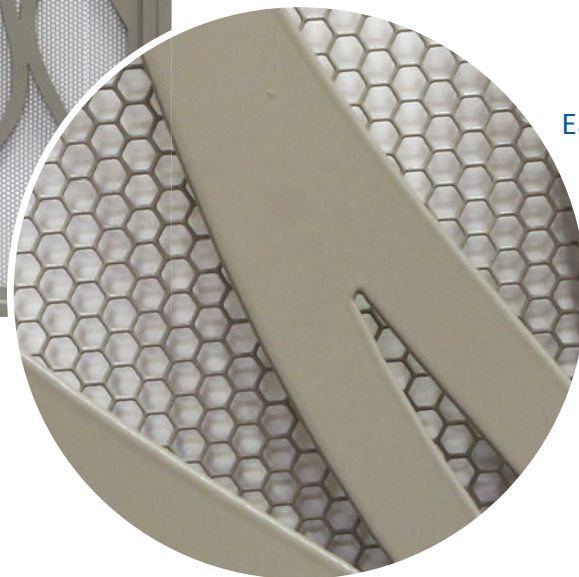

Each door includes a screen panel with 18-16 charcoal screen mesh.

MADE IN THE  
USA 



# ASK ABOUT CUSTOM WATER JET CUT PATTERNS

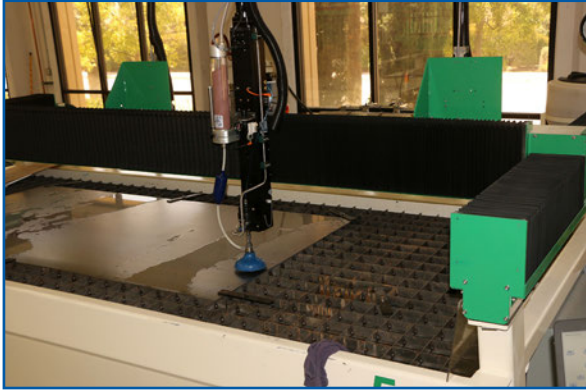

Precision can help design\* and manufacture custom panels for security doors, fencing & gates.

## DESIGN INSPIRATION

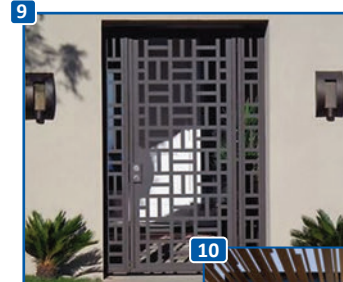
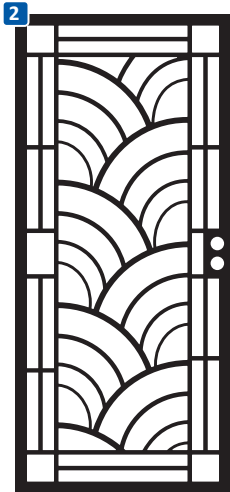
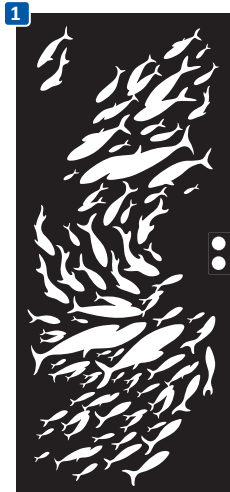

\*Design fee may apply



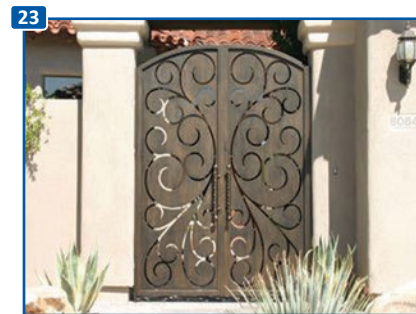
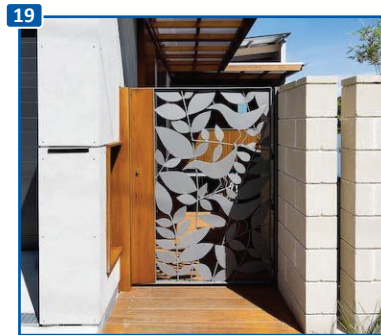
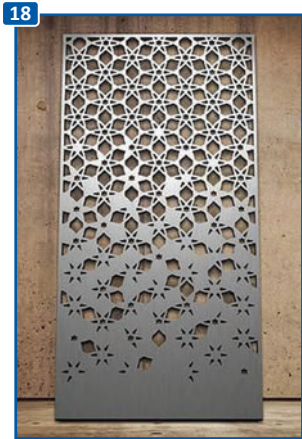
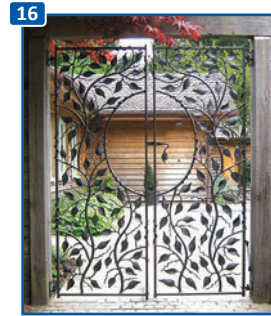
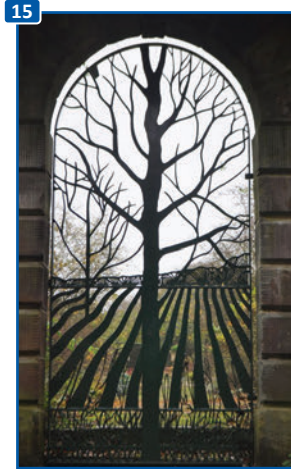
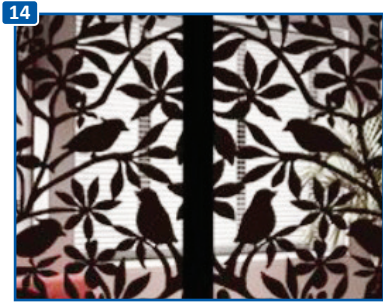
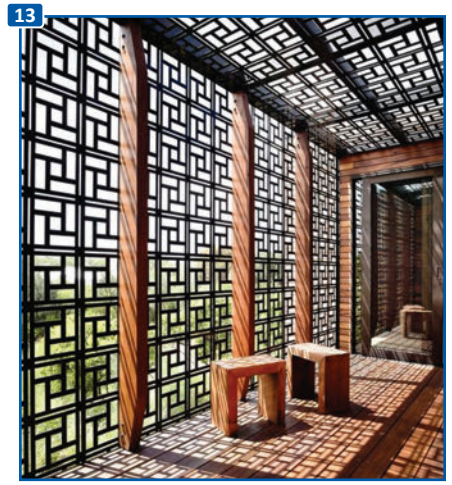
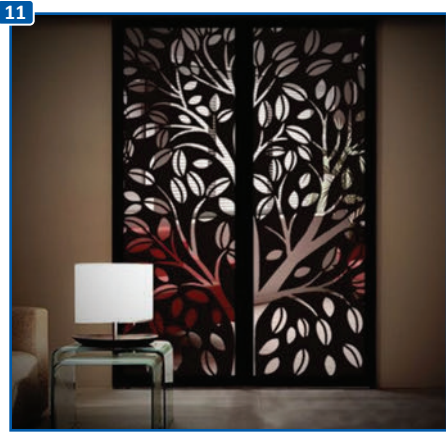

# — NEW WATER JET DOORS —

Product Line G3007

- Door series are built to order
- Water jet designs are cut from Sheet Steel
- Standard and custom sizes available
- Doors available in adobe, almond, black, bronze, weathered brown, or white
- Contrasting color mesh (as shown) is an upgrade for an additional charge

## ARIZONA

6875 Single / 7875 Double



## ABERDEEN

6830 Single / 7830 Double

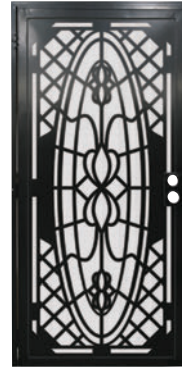

## BEACON

6800 Single / 7800 Double



## CALYPSO

6833 Single / 7833 Double



## DECO

3842 Single / 5842 Double



## DYNASTY

6845 Single / 7845 Double



## ECLIPSE

6812 Single / 7812 Double



## FIORI

6840 Single / 7840 Double



## GEOTIC

6876 Single / 7876 Double



## LAVENDER

6809 Single / 7809 Double



## MONACO

6807 Single / 7807 Double





# — NEW WATER JET DOORS —

Product Line G3007

## NOUVEAU

6835 Single / 7835 Double



## PORTICO

6802 Single / 7802 Double



## SAN MARINO

3840 Single / 5840 Double



## SHERWOOD

6803 Single / 7803 Double



## STARFIRE

6801 Single / 7801 Double

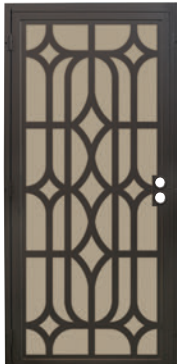

## SOUTHWEST

3837 Single / 5837 Double



## STEPLOCK

6810 Single / 7810 Double

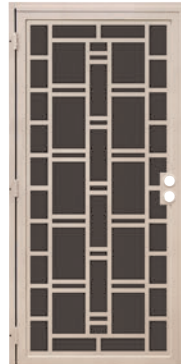

## SURREY

6839 Single / 7839 Double



## VICTORIAN

6806 Single / 7806 Double



## VINEYARD

3823 Single / 5823 Double



## VINEYARD FULL

3826 Single / 5826 Double

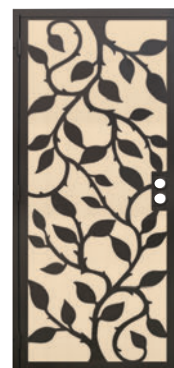

MADE IN THE  
USA 



**Features**

- Standard sizes:  
2'6 in. x 6'8 in. (33 in. x 81-3/4 in. Net overall frame)  
2'8 in. x 6'8 in. (35 in. x 81-3/4 in. Net overall frame)  
3'0 in. x 6'8 in. (39 in. x 81-3/4 in. Net overall frame)
- Custom sizes available
- 1-1/4 in. sq. x 18 Ga. 3-piece steel mounting frame
- 1 in. sq. x 18 Ga. steel door frame
- 1/2 in. sq. x 18 Ga. steel pickets
- Removeable "Hummingbird" insert, water jet cut from 1/8 in. steel
- For optional insert designs - refer to page 46
- Double hole lock-box w/ 2-1/8 in. bore & 2-3/8 in. backset
- Continuous 1/8 in. x 3/4 in. lock side "tamper guard"
- Tamper proof hinges
- 24 Ga. perforated steel mesh for extra security
- Contrasting color mesh (as shown) is an upgrade for an additional charge
- See page 18 for finishes



Paradise shown with optional Dolphin



Product Line G3007



**MADE IN THE  
USA** 

### Features

- This door series is built to order
- Standard size:  
3'0 in. x 6'8 in. (39 in. x 81-3/4 in. Net overall frame)
- Custom sizes available
- 1-1/4 in. sq. x 18 Ga. 3 piece steel mounting frame
- 1 in. sq. x 18 Ga. steel door frame
- 5/8 in. sq. x 18 Ga. vertical pickets
- Removable "Longevity" insert, water jet cut from 1/8 in. steel
- Signature design at top and bottom
- For optional insert designs - refer to page 46
- Double hole lock-box w/ 2-1/8 in. bore & 2-3/8 in. backset
- Continuous 1/8 in. x 3/4 in. lock side "tamper guard"
- Tamper proof hinges
- 24 Ga. perforated steel mesh for extra security
- Non-handed
- Contrasting color mesh (as shown) is an upgrade for an additional charge
- See page 18 for finishes



Longevity door shown with optional 4-sided frame (option shown has additional cost)



**Features**

- This door series is built to order
- Standard sizes:  
2'6 in. x 6'8 in. (33 in. x 81-3/4 in. Net overall frame)  
2'8 in. x 6'8 in. (35 in. x 81-3/4 in. Net overall frame)  
3'0 in. x 6'8 in. (39 in. x 81-3/4 in. Net overall frame)
- Custom sizes available
- 1-1/4 in. sq. x 18 Ga. 3-piece steel mounting frame
- 1 in. sq. x 18 Ga. steel door frame
- 1/2 in. sq. x 18 Ga. steel pickets
- Removable "Welcome" insert
- For optional insert designs - refer to page 46
- Double hole lock-box w/ 2-1/8 in. bore & 2-3/8 in. backset
- Continuous 1/8 in. x 3/4 in. lock side "tamper guard"
- Tamper proof hinges
- 24 Ga. perforated steel mesh for extra security
- Non-handed
- Contrasting color mesh (as shown) is an upgrade for an additional charge
- See page 18 for finishes



Impressions shown with optional Happy Holidays insert





Product Line G3007



### Features

- This door series is built to order
- Custom sizes available
- 1-1/4 in. sq. x 18 Ga. 3-piece mounting frame
- 1 in. sq. x 18 Ga. steel door frame
- 1/2 in. sq. x 18 Ga. vertical steel pickets
- 3/4 in. sq. x 18 Ga. horizontal steel pickets
- Double hole lock-box w/ 2-1/8 in. bore & 2-3/8 in. backset
- Continuous 1/8 in. x 3/4 in. lock side "tamper guard"
- Tamper proof hinges
- 24 Ga. perforated steel mesh for extra security
- Non-handed
- Contrasting color mesh (as shown) is an upgrade for an additional charge
- See page 18 for finishes



Window guard designed to complement our Franciscan steel security door

**MADE IN THE**  
**USA** 

**Features**

- 1-1/2 in. sq. x 16 Ga. 1-piece, 3-sided steel mounting frame
- 1 in. sq. x 18 Ga. steel door frame
- 3/4 in. sq. x 18 Ga. horizontal pickets
- 5/8 in. sq. x 18 Ga. vertical pickets
- 1/4 in. x 12 in. steel scrolls w/leaves
- Decorative collars on pickets
- Double hole lock-box, w/ 2-1/8 in. bore & 2-3/8 in. backset
- Continuous 1/8 in. x 1 in. steel top & lock side "tamper guard"
- Tamper proof hinges
- 24 Ga. perforated steel mesh for extra security
- Specify left or right side hinges (from outside looking in)
- Contrasting color mesh (as shown) is an upgrade for an additional charge
- See page 18 for finishes

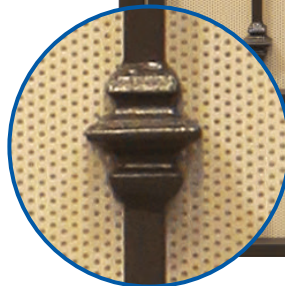

\*Specify active side





Product Line G3007

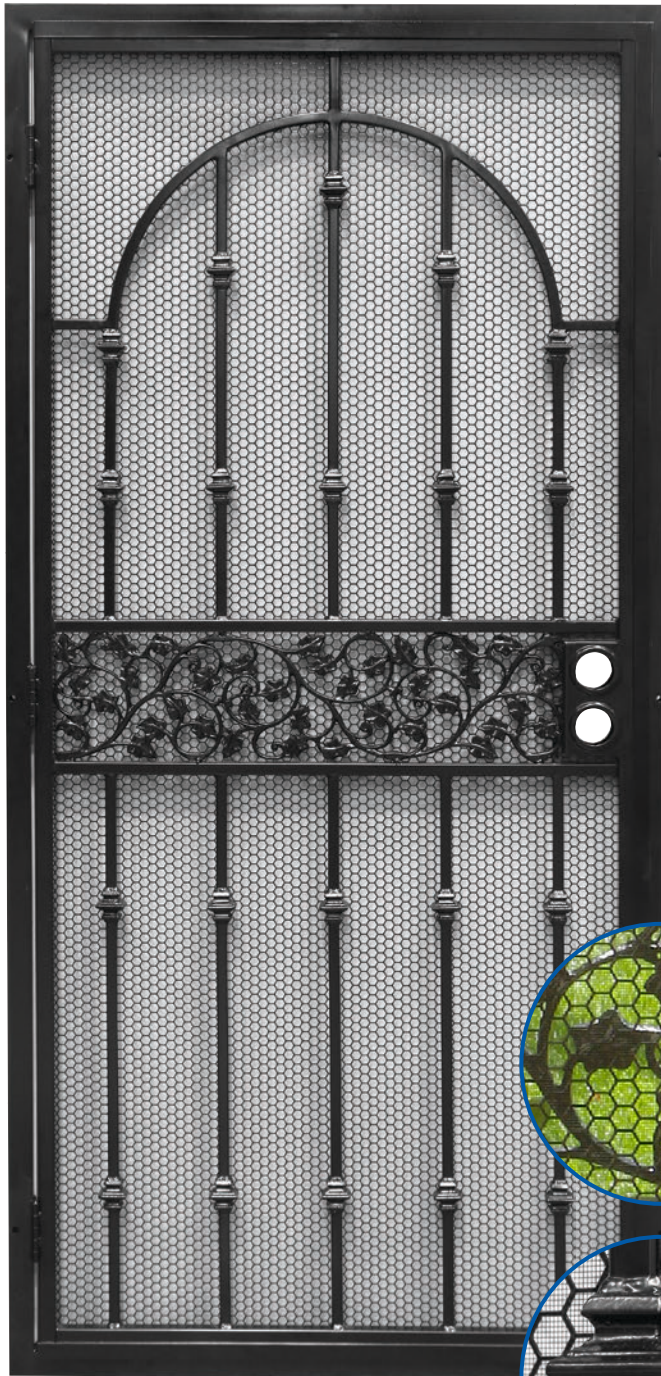

### Features

- 1-1/2 in. sq. x 16 Ga. 1-piece, 3-sided steel mounting frame
- 1 in. sq. x 18 Ga. steel door frame
- 3/4 in. sq. x 18 Ga. horizontal steel pickets
- 5/8 in. sq. x 18 Ga. vertical & arched pickets
- Aluminum ivy casting at center
- Decorative collars on pickets
- Double hole lock-box w/ 2-1/8 in. bore & 2-3/8 in. backset
- Continuous 1/8 in. x 1 in. steel top & lock side "tamper guard"
- Tamper proof hinges
- 24 Ga. perforated steel mesh for extra security
- **Specify left or right side hinges (from outside looking in)**
- Contrasting color mesh is an upgrade for an additional charge
- **High air flow hex perf mesh with screen (as shown) is an upgrade for an additional charge**
- See page 18 for finishes

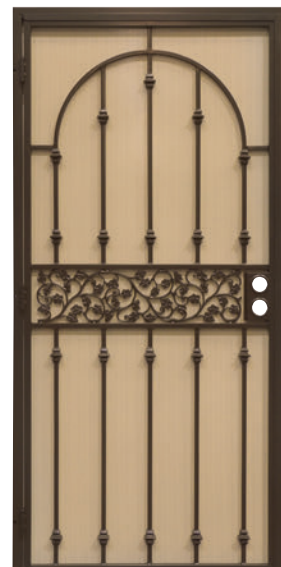
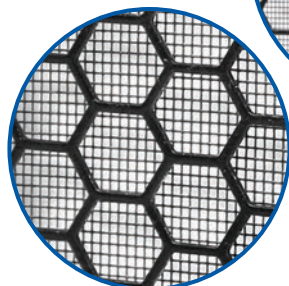
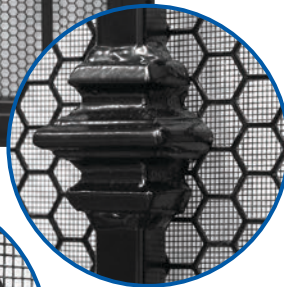
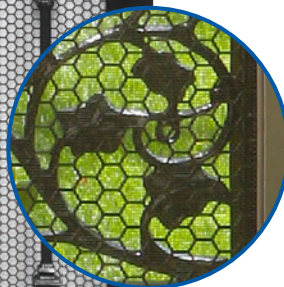

English Ivy shown with standard perforated mesh

Contrast mesh shown has additional cost

**MADE IN THE USA**

\* 35" MINIMUM FRAME WIDTH \*



**Features**

- 1-1/2 in. sq. x 16 Ga. 1-piece, 3-sided steel mounting frame
- 1 in. sq. x 18 Ga. steel door frame
- 3/4 in. sq. x 18 Ga. horizontal steel pickets
- 5/8 in. sq. x 18 Ga. vertical & arched pickets
- Aluminum grape vine casting at center
- Aluminum grape vine casting at top
- Double hole lock-box w/ 2-1/8 in. bore & 2-3/8 in. backset
- Continuous 1/8 in. x 1 in. steel top & lock side "tamper guard"
- Tamper proof hinges
- 24 Ga. perforated steel mesh for extra security
- **Specify left or right side hinges (from outside looking in)**
- Contrasting color mesh (as shown) is an upgrade for an additional charge
- See page 18 for finishes

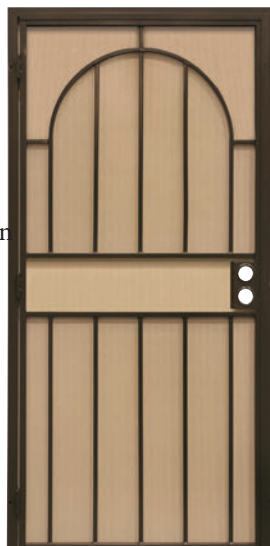
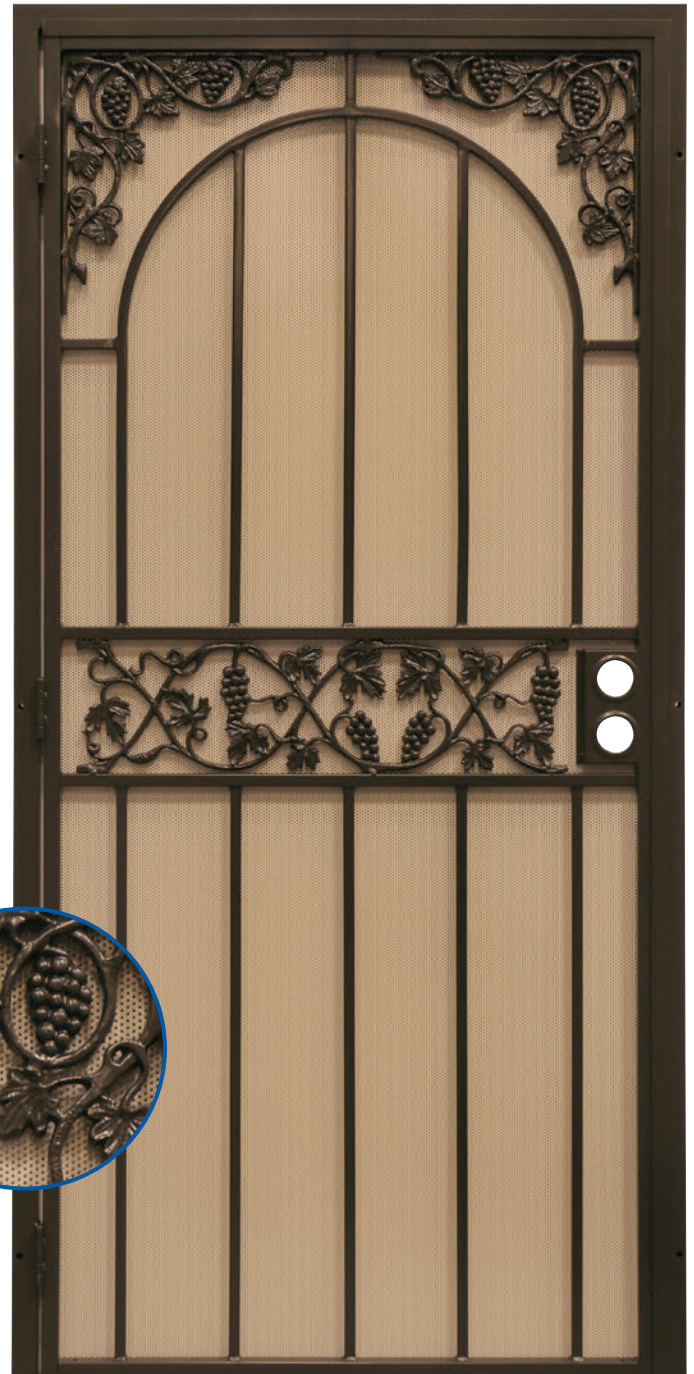

Sonoma shown with castings removed

Contrast mesh shown has additional cost



\* 35" MINIMUM FRAME WIDTH \*



Product Line G3007

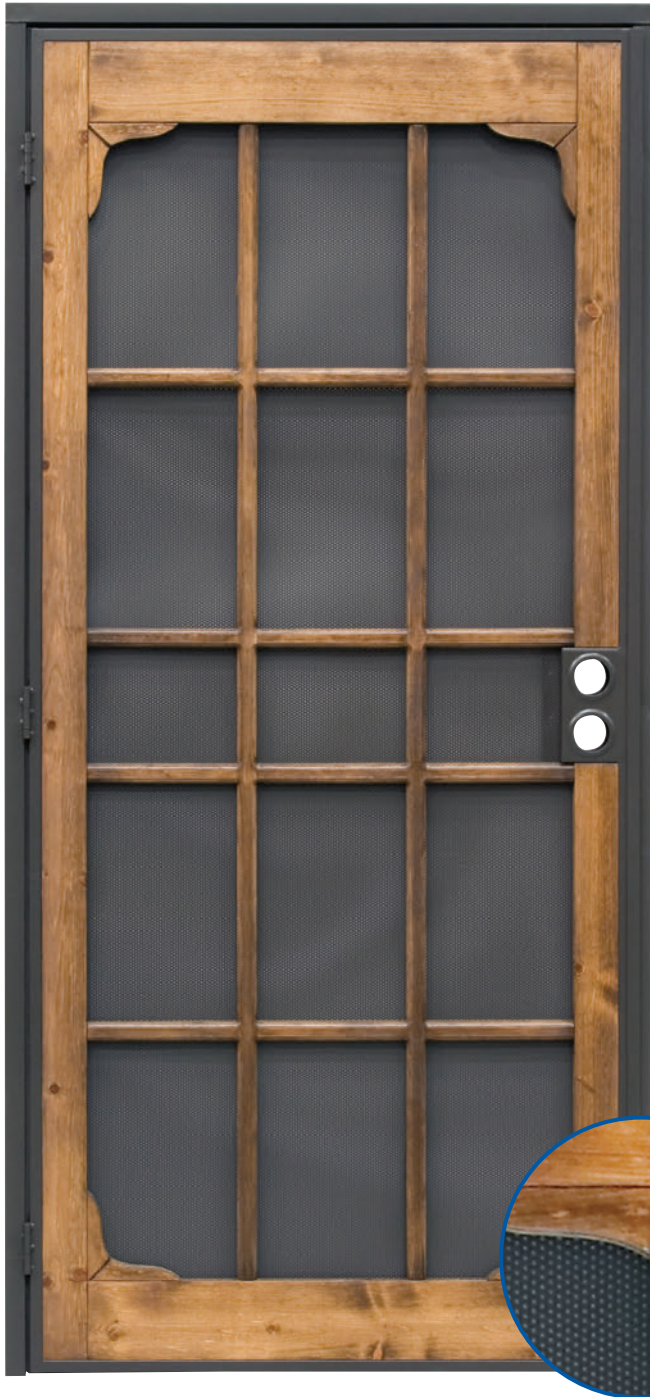

**MADE IN THE  
USA** 

### Features

- Standard sizes:
  - 2'6 in. x 6'8 in. (33 in. x 81-3/4 in. Net overall frame)
  - 2'8 in. x 6'8 in. (35 in. x 81-3/4 in. Net overall frame)
  - 3'0 in. x 6'8 in. (39 in. x 81-3/4 in. Net overall frame)
- Custom sizes available
- 1-1/4 in. sq. x 18 Ga. 3-piece steel mounting frame
- 1 in. sq. x 18 Ga. steel door frame
- Double hole lock-box w/ 2-1/8 in. bore & 2-3/8 in. backset
- Continuous 1/8 in. x 3/4 in. lock side “tamper guard”
- Tamper proof hinges
- 24 Ga. perforated steel mesh for extra security
- 3/4 in. Thick pine wood, colonial pattern with light oak stain insert
- Non-handed
- Contrasting color mesh is an upgrade for an additional charge
- See page 18 for finishes
- **Wood insert is only available in oak stain**
- **Allow additional lead time for custom sizes**

Please note: Due to natural variations in texture, wood density, and grain patterns, color tones may differ.

This could be most noticeable on double door installations.

**Features**

- Standard sizes:  
2'6 in. x 6'8 in. (33 in. x 81-3/4 in. Net overall frame)  
2'8 in. x 6'8 in. (35 in. x 81-3/4 in. Net overall frame)  
3'0 in. x 6'8 in. (39 in. x 81-3/4 in. Net overall frame)
- Custom sizes available
- 1-1/4 in. sq. x 18 Ga. 3-piece steel mounting frame
- 1 in. x 2 in. x 16 Ga. steel door frame
- 1 in. sq. x 18 Ga. steel horizontal tubes at lock-box, top, & bottom
- 1/2 in. sq. x 18 Ga. vertical steel pickets
- 1/2 in. sq. x 18 Ga. horizontal steel pickets at top, center & bottom
- 11 Ga. Zuni designs at top, center, & bottom
- Double hole lock-box w/ 2-1/8 in. bore & 2-3/8 in. backset
- Continuous 1/8 in. x 3/4 in. lock side “tamper guard”
- Tamper proof hinges
- 24 Ga. perforated steel mesh for extra security
- Non-handed
- Contrasting color mesh (as shown) is an upgrade for an additional charge
- See page 18 for finishes



Dakota shown with  
Zunis removed

Contrast mesh shown  
has additional cost





Product Line G3007



**MADE IN THE  
USA** 

\* 35" MINIMUM FRAME WIDTH \*

### Features

- Standard sizes:
  - 2'6 in. x 6'8 in. (33 in. x 81-3/4 in. Net overall frame)
  - 2'8 in. x 6'8 in. (35 in. x 81-3/4 in. Net overall frame)
  - 3'0 in. x 6'8 in. (39 in. x 81-3/4 in. Net overall frame)
- Custom sizes available
- 1-1/4 in. sq. x 18 Ga. 3-piece steel mounting frame
- 1 in. x 2 in. x 16 Ga. steel door frame
- 1 in. sq. x 18 Ga. steel horizontal tubes at lock-box, top, & bottom
- 1/2 in. sq. x 18 Ga. vertical steel pickets
- 1/2 in. sq. x 18 Ga. horizontal steel pickets at top, center & bottom
- Decorative cast grille
- Double hole lock-box w/ 2-1/8 in. bore & 2-3/8 in. backset
- Continuous 1/8 in. x 3/4 in. lock side "tamper guard"
- Tamper proof hinges
- 24 Ga. perforated steel mesh for extra security
- Non-handed
- Contrasting color mesh (as shown) is an upgrade for an additional charge
- See page 18 for finishes

\*Specify active





**Features**

- Standard sizes:  
2'6 in. x 6'8 in. (33 in. x 81-3/4 in. Net overall frame)  
2'8 in. x 6'8 in. (35 in. x 81-3/4 in. Net overall frame)  
3'0 in. x 6'8 in. (39 in. x 81-3/4 in. Net overall frame)
- Custom sizes available
- 1-1/4 in. sq. x 18 Ga. 3-piece steel mounting frame
- 1 in. sq. x 18 Ga. steel door frame
- 1 in. sq. x 18 Ga. steel horizontal tubes at lock-box
- 1/2 in. sq. x 18 Ga. vertical steel pickets (2 twisted - 3 straight)
- Ten signature aluminum castings
- Double hole lock-box w/ 2-1/8 in. bore & 2-3/8 in. backset
- Continuous 1/8 in. x 3/4 in. lock side "tamper guard"
- Tamper proof hinges
- 24 Ga. perforated steel mesh for extra security
- Non-handed
- Contrasting color mesh (as shown) is an upgrade for an additional charge
- See page 18 for finishes



Product Line G3007



### Features

- Standard sizes:
  - 2'6 in. x 6'8 in. (33 in. x 81-3/4 in. Net overall frame)
  - 2'8 in. x 6'8 in. (35 in. x 81-3/4 in. Net overall frame)
  - 3'0 in. x 6'8 in. (39 in. x 81-3/4 in. Net overall frame)
- Custom sizes available
- 1-1/4 in. sq. x 18 Ga. 3-piece mounting frame
- 1 in. sq. x 18 Ga. steel door frame
- 1/2 in. sq. x 18 Ga. vertical steel pickets
- 1/2 in. sq. x 18 Ga. horizontal steel pickets
- Two signature aluminum castings
- Double hole lock-box w/ 2-1/8 in. bore & 2-3/8 in. backset
- Continuous 1/8 in. x 3/4 in. lock side "tamper guard"
- Tamper proof hinges
- 24 Ga. perforated steel mesh for extra security
- Non-handed
- Contrasting color mesh (as shown) is an upgrade for an additional charge
- See page 18 for finishes

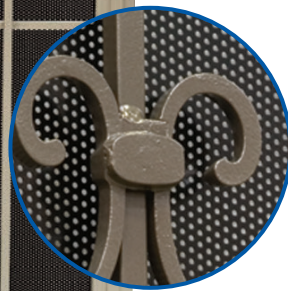

Granada shown with castings removed.

**MADE IN THE  
USA** 



**Features**

- Standard sizes:
  - 2'6 in. x 6'8 in. (33 in. x 81-3/4 in. Net overall frame)
  - 2'8 in. x 6'8 in. (35 in. x 81-3/4 in. Net overall frame)
  - 3'0 in. x 6'8 in. (39 in. x 81-3/4 in. Net overall frame)
- Custom sizes available
- 1-1/4 in. sq. x 18 Ga. 3-piece steel mounting frame
- 1 in. sq. x 18 Ga. steel door frame
- 1/2 in. sq. x 18 Ga. vertical steel pickets
- 1/2 in. sq. x 18 Ga. horizontal steel pickets
- 1/8 in. Thick x 1/2 in. wide steel scroll design
- Double hole lock-box w/ 2-1/8 in. bore & 2-3/8 in. backset
- Continuous 1/8 in. x 3/4 in. lock side "tamper guard"
- Tamper proof hinges
- 24 Ga. perforated steel mesh for extra security
- Non-handed
- Contrasting color mesh (as shown) is an upgrade for an additional charge
- See page 18 for finishes



**MADE IN THE**  
**USA** 



Product Line G3007



**MADE IN THE  
USA** 

### Features

- Standard sizes:
  - 2'6 in. x 6'8 in. (33 in. x 81-3/4 in. Net overall frame)
  - 2'8 in. x 6'8 in. (35 in. x 81-3/4 in. Net overall frame)
  - 3'0 in. x 6'8 in. (39 in. x 81-3/4 in. Net overall frame)
- Custom sizes available
- 1-1/4 in. sq. x 18 Ga. 3-piece steel mounting frame
- 1 in. sq. x 18 Ga. steel door frame
- 1 in. sq. x 18 Ga. steel horizontal tubes at lock-box
- 1/2 in. sq. x 18 Ga. vertical steel pickets (Every other twisted: 3 twisted - 2 straight)
- 1/2 in. sq. x 18 Ga. horizontal steel pickets
- 1/8 in. thick x 1/2 in. wide steel scroll designs
- Double hole lock-box w/ 2-1/8 in. bore & 2-3/8 in. backset
- Continuous 1/8 in. x 3/4 in. lock side "tamper guard"
- Tamper proof hinges
- 24 Ga. perforated steel mesh for extra security
- Non-handed
- Contrasting color mesh is an upgrade for an additional charge
- See page 18 for finishes

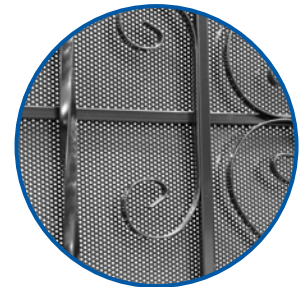



## Features

- Standard sizes:
  - 2'6 in. x 6'8 in. (33-1/2 in. x 82 in. Net overall frame)
  - 2'8 in. x 6'8 in. (35-1/2 in. x 82 in. Net overall frame)
  - 3'0 in. x 6'8 in. (39-1/2 in. x 82 in. Net overall frame)
- Custom sizes available
- **1-1/2 in. sq. x 16 Ga. one piece - 3 sided steel mounting frame**
- 1 in. sq. x 18 Ga. steel door frame
- 5/8 in. sq. x 18 Ga. vertical steel pickets
- 3/8 in. sq. x 18 Ga. horizontal steel pickets
- 1/8 in. thick x 1/2 in. wide steel scroll designs
- Double hole lock-box w/ 2-1/8 in. bore & 2-3/8 in. backset
- **Lock ring guard included**
- Continuous 1/8 in. x 1 in. steel top & lock side "tamper guard"
- Tamper proof hinges
- 24 Ga. perforated steel mesh for extra security
- **Specify left or right side hinges (from outside looking in)**
- Contrasting color mesh is an upgrade for an additional charge
- See page 18 for finishes

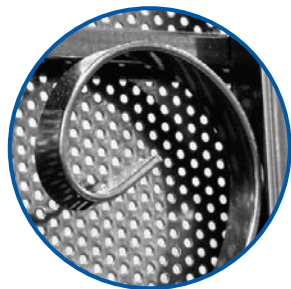

MADE IN THE  
USA

Product Line G3007



**MADE IN THE  
USA** 

### Features

- Standard sizes:
  - 2'6 in. x 6'8 in. (33 in. x 81-3/4 in. Net overall frame)
  - 2'8 in. x 6'8 in. (35 in. x 81-3/4 in. Net overall frame)
  - 3'0 in. x 6'8 in. (39 in. x 81-3/4 in. Net overall frame)
- Custom sizes available
- 1-1/4 in. sq. x 18 Ga. 3-piece steel mounting frame
- 1 in. x 2 in. x 16 Ga. steel door frame
- 5/8 in. sq. x 18 Ga. crescent picket at lock-box
- 1/2 in. sq. x 18 Ga. radiant pickets
- Double hole lock-box w/ 2-1/8 in. bore & 2-3/8 in. backset
- Continuous 1/8 in. x 3/4 in. lock side “tamper guard”
- Tamper proof hinges
- 24 Ga. perforated steel mesh for extra security
- Non-handed
- Contrasting color mesh (as shown) is an upgrade for an additional charge
- See page 18 for finishes

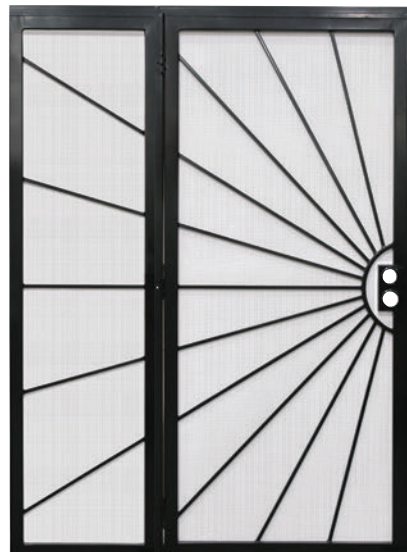

Shown with optional side-lite. Double side-lites also available.  
(option shown has additional cost)



**Features**

- Standard sizes:  
2'6 in. x 6'8 in. (33 in. x 81-3/4 in. Net overall frame)  
2'8 in. x 6'8 in. (35 in. x 81-3/4 in. Net overall frame)  
3'0 in. x 6'8 in. (39 in. x 81-3/4 in. Net overall frame)
- Custom sizes available
- 1-1/4 in. sq. x 18 Ga. 3-piece steel mounting frame
- 1 in. x 2 in. x 18 Ga. steel door frame
- 1/2 in. sq. x 18 Ga. radiant pickets
- Double hole lock-box w/ 2-1/8 in. bore & 2-3/8 in. backset
- Continuous 1/8 in. x 3/4 in. lock side "tamper guard"
- Tamper proof hinges
- 24 Ga. perforated steel mesh for extra security
- Non-handed
- Contrasting color mesh (as shown) is an upgrade for an additional charge
- See page 18 for finishes



Solara shown with optional cactus insert. Available at additional cost.



Product Line G3007

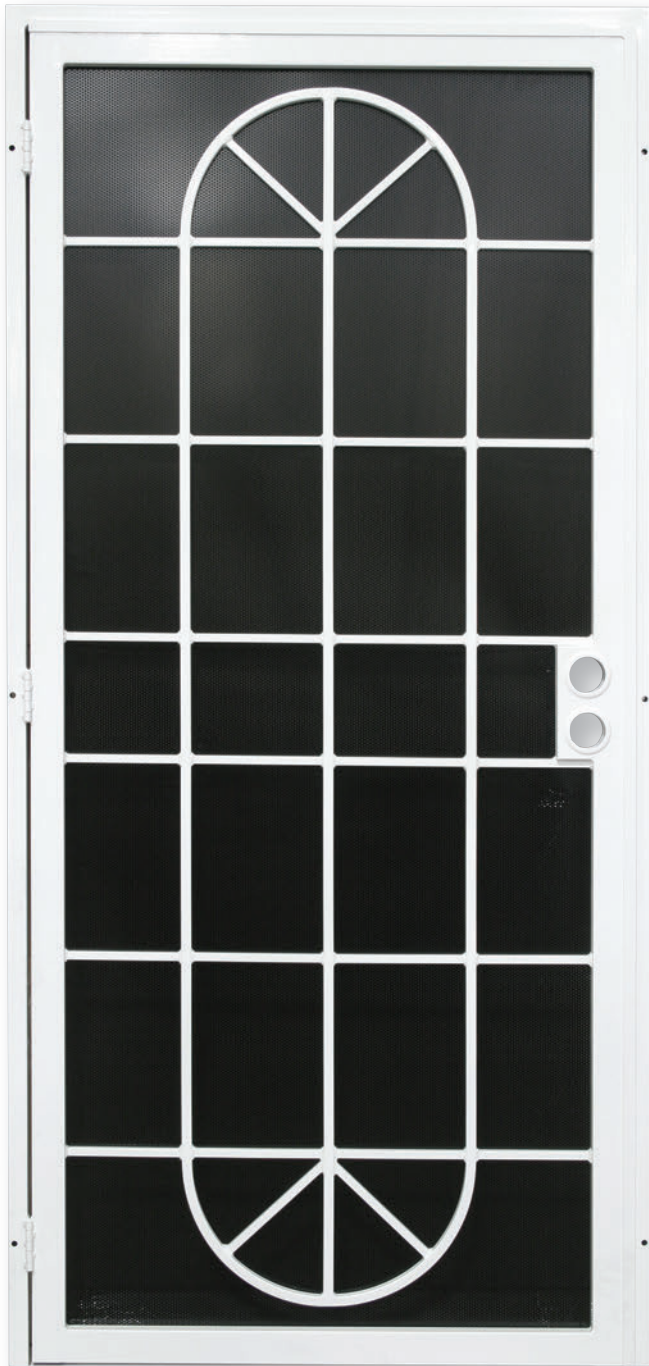

**MADE IN THE  
USA** 

### Features

- Standard sizes:
  - 2'6 in. x 6'8 in. (33 in. x 81-3/4 in. Net overall frame)
  - 2'8 in. x 6'8 in. (35 in. x 81-3/4 in. Net overall frame)
  - 3'0 in. x 6'8 in. (39 in. x 81-3/4 in. Net overall frame)
- Custom sizes available
- 1-1/4 in. sq. x 18 Ga. 3-piece steel mounting frame
- 1 in. sq. x 18 Ga. steel door frame
- 5/8 in. sq. x 18 Ga. vertical steel pickets
- 1/2 in. sq. x 18 Ga. horizontal steel pickets
- Double hole lock-box w/ 2-1/8 in. bore & 2-3/8 in. backset
- Continuous 1/8 in. x 3/4 in. lock side "tamper guard"
- Tamper proof hinges
- 24 Ga. perforated steel mesh for extra security
- Non-handed
- Contrasting color mesh (as shown) is an upgrade for an additional charge
- See page 18 for finishes



Clarion shown with the bottom arch and radiants removed

Contrast mesh shown has additional cost



**Features**

- Standard sizes:  
 2'6 in. x 6'8 in. (33 in. x 81-3/4 in. Net overall frame)  
 2'8 in. x 6'8 in. (35 in. x 81-3/4 in. Net overall frame)  
 3'0 in. x 6'8 in. (39 in. x 81-3/4 in. Net overall frame)
- Custom sizes available
- 1-1/4 in. sq. x 18 Ga. 3-piece steel mounting frame
- 1 in. x 2 in. x 16 Ga. steel door frame
- 5/8 in. sq. x 18 Ga. vertical steel pickets
- 1/2 in. sq. x 18 Ga. horizontal steel pickets
- Double hole lock-box w/ 2-1/8 in. bore & 2-3/8 in. backset
- Continuous 1/8 in. x 3/4 in. lock side “tamper guard”
- Tamper proof hinges
- 24 Ga. perforated steel mesh for extra security
- Non-handed
- Contrasting color mesh (as shown) is an upgrade for an additional charge
- See page 18 for finishes



Many of our steel security doors can have a pet door installed. Carolina shown with the medium pet door. Options shown have



# STEEL SECURITY DOORS

Custom options (add-ons) for domestic steel security doors

Product Line Z9999 for all options on this page

Option	Option Code	Description
<b>Mounting Variations</b> (Refer to Page 58)	OP-SurfaceMt	Surface mount (standard)
	OP-InsetMt	Inset mount
	OP-InstMtTab	Inset mount w/tabs (specify tab size)
	OP-SurfMtTab	Surface mount w/tabs (specify tab size)
	OP-SMStndOffTab	Surface mount w/stand-off tabs (specify tab size)
	OP-SMTubeBack	Surface mount w/tube backing
	OP-IMFullStrap	Inset mount w/full strapping (specify strapping width)
	OP-IMSurfTab	Inset mount w/surface tabs (specify tab size)
<b>Frame Variations</b>	OP-3Piece	Three piece - door w/hinge bar, header bar, & strike bar (standard)
	OP-1Pc3Side1.25	One piece 3-sided 1-1/4 in. pre-hung frame
	OP-1Pc3Side1.5	One piece 3-sided 1-1/2 in. pre-hung frame
	OP-1Pc4Side1.25	One piece 4-sided 1-1/4 in. pre-hung frame
	OP-1Pc4Side1.5	One piece 4-sided 1-1/2 in. pre-hung frame
<b>Double Door</b>		Set-up (price of two custom doors and add:)
	OP-DDCaneBolts	Double door w/cane-bolts (standard)
	OP-DDFlushBolts	Double door w/flush extension bolts in door stile
<b>Lock-Box</b>	OP-INSTL8560	Single hole lock-box
	OP-RingGuard	Ring guard - welded
	OP-HandlePull	Handle pull
	OP-SpecLBlOc	Special lock-box location
<b>Door Coverings</b>	OP-24GaPerf	24 Ga. perforated steel mesh w/ 3/32 in. dia holes (standard)
	OP-ContPerf	Contrasting color perforated mesh
	OP-16GaExpnd	16 Ga. 1/2 in. expanded metal screen
	OP-13GaExpnd	13 Ga. 1/2 in. expanded metal screen
	OP-24GaSolid	24 Ga. solid sheet metal
	OP-HexPerfScreen-16	16 Ga. hexagon perforated steel mesh w/ screen
	OP-HexPerfScreen-22	22 Ga. hexagon perforated steel mesh w/ screen
	OP-NoPerf	No covering
<b>Mail Slots</b>	OP-MailSlitNoCvr	Cut-out, no cover (12 in. x 3 in. I.D.)
	OP-MailSlitWCvr	Cut-out, with cover (12 in. x 3 in. I.D.)
<b>Pet Door Cut-Outs</b>	OP-PD-CUTOUT-S	Cut-out for small pet door
	OP-PD-CUTOUT-M	Cut-out for medium pet door
	OP-PD-CUTOUT-L	Cut-out for large pet door
	OP-PD-CUTOUT-X	Cut-out for extra-large pet door
<b>Pet Door Installed</b>	OP-PD-STL-S	Cut-out and install small pet door
	OP-PD-STL-M	Cut-out and install medium pet door
	OP-PD-STL-L	Cut-out and install large pet door
	OP-PD-STL-X	Cut-out and install extra large pet door
<b>Transoms (Up to 24 in. High)</b>	OP-Trnsm-NoPerf	To doors with no perforated steel mesh
	OP-Trnsm-Perf	To doors with perforated steel mesh
	OP-Trnsm-Perf	To doors with expanded metal mesh
	OP-ArchedTop	Arched doors one piece pre-hung frame only - specify handing, provide template
<b>Hydraulic Closer</b>	OP-HydraulicClr	Hydraulic closer (not installed); mounting plates welded to frame & door (Gray only)
<b>Primer</b>	OP-Primerpaint	Primer undercoat + paint for extra rust protection

*See price list for additional "OP" options*

## SECURITY DOOR ACCESSORIES

Option	Product Line	Description
2126BZ	F3970	Standard door closer, bronze
2126BK	F3970	Standard door closer, black
2127BK	G8002	Heavy duty closer, black
213007	G8002	Hydraulic door closer w/plates, gray only

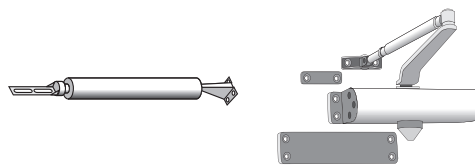

















# REMOVABLE INSERT DESIGNS

For Vineyard, Paradise, Impressions & Longevity doors

Product Line - G8805

Standard colors: Adobe, almond, black, bronze, white or weathered brown

Part Number	Description	Option Code	Part Number	Description	Option Code		
	8853006	Cactus	OP-Cactus		8853010	Humming bird <i>Included standard with Paradise doors</i>	OP-Hummingbird
	8853001	Coyote	OP-Coyote		8853011	Longevity <i>Included standard with Longevity doors</i>	OP-Longevity
	8853012	Happy Holidays	OP-		8853004	Love birds	OP-Lovebirds
	8853002	Dolphins	OP-Dolphin		8853005	Palm tree	OP-PalmTree
	8853003	Gecko	OP-Gecko		8853008	Welcome <i>Included standard with Impressions &amp; Vineyard doors</i>	OP-Welcome
	8853007	Horse	OP-Horse		8853013	Whale tail	OP-Whaletail
	8853014	Pineapple	OP-Pineapple		8853015	Hawaii	OP-Hawaii

## Door Mesh Options

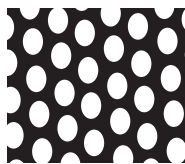

24 Ga.  
Perforated

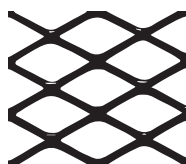

16 Ga. 1/2"  
Expanded

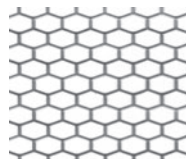

16 Ga.  
Hex Perf

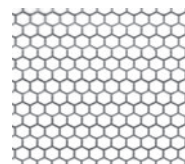

22 Ga.  
Hex Perf

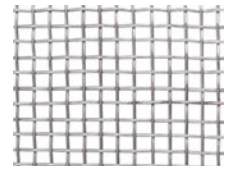

Stainless Steel Mesh  
(Black Finish only)

# PATIO DOOR & PORCH ENCLOSURES

CENTURION

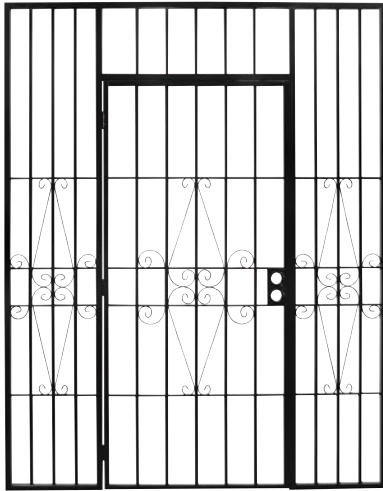

Porch

KNIGHTGUARD

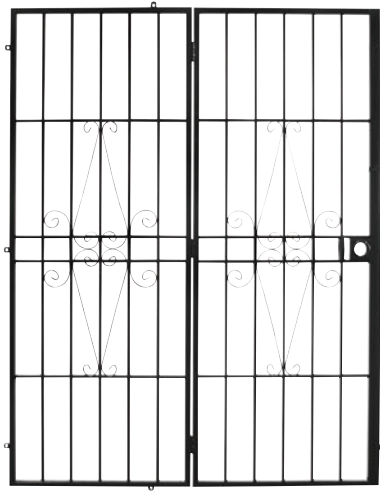

Patio

SENTINEL



Patio

Most single door patterns can be ordered on the above systems.  
Refer to each page for limitations.

*Example: Franciscan sliding patio door*





**Features**

- Double hole lock-box w/ 2-1/8 in. bore & 2-3/8 in. backset
- Continuous 1/8 in. x 1 in. “tamper guard” on lock side & top
- Tamper proof hinges
- Optional 24 Ga. perforated steel mesh for extra security is available as an upgrade for an additional charge
- Optional 16 Ga. expanded steel mesh for extra security is available as an upgrade for an additional charge

**Must specify handing**

- Built to order
- See page 18 for finishes
- Specify door width

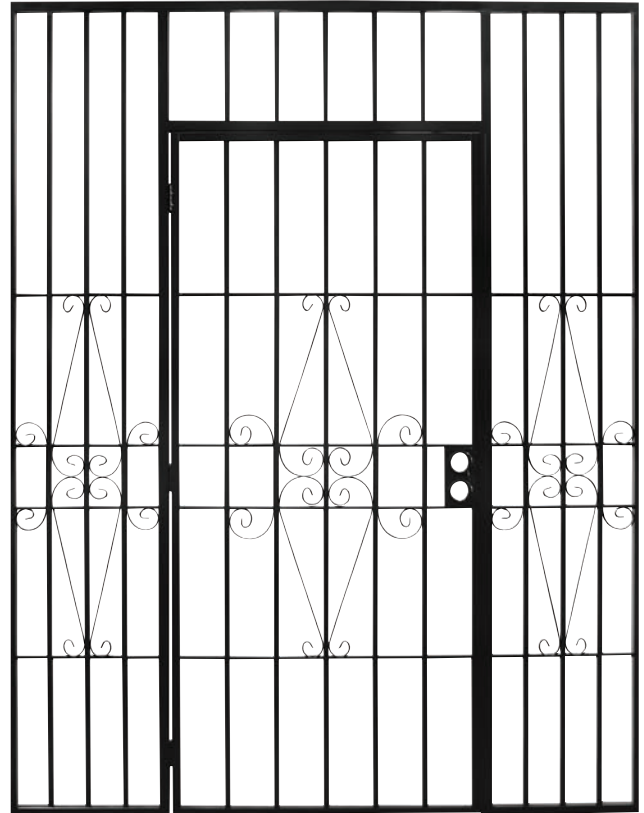

Up to:	Up to:	Up to:	Up to:	Up to:
7'0 in. x 8'0 in.	9'0 in. x 8'6 in.	11'0 in. x 8'6 in.	13'0 in. x 8'6 in.	15'0 in. x 9'0 in.
84 in. x 96 in.	108 in. x 100 in.	132 in. x 100 in.	156 in. x 100 in.	180 in. x 108 in.

Call for quote on any size or options not shown



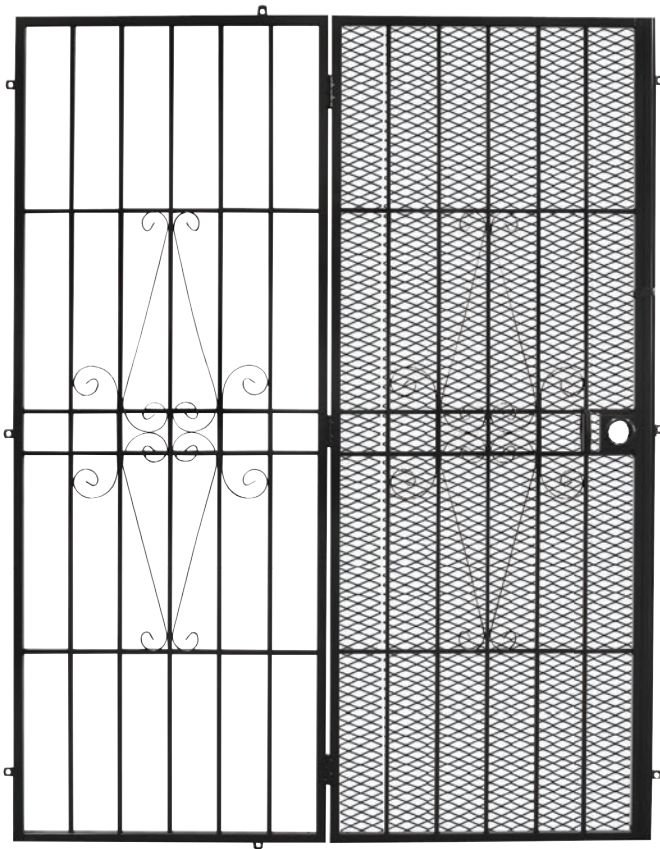

### Features

- Single hole lock-box w/ 2-1/8 in. bore & 2-3/8 in. backset
  - Continuous 1/8 in. x 3/4 in. lock side “tamper guard”
  - Tamper proof hinges
  - Standard 24 Ga. perforated steel mesh for extra security
  - Optional 16 Ga. expanded metal (1/2 in.) on active door (option shown) is available as an upgrade for an additional charge
- **Must specify handing**
- Hinged at center
  - 1 in. Stand-off tab standard
  - Built to order
  - See page 18 for finishes
  - Hinged steel patio security door can be ordered using most of our “Steel Security Door” designs.

Up to:	Up to:	Up to:	Up to:	Up to:
5'0 in. x 6'8 in.	6'0 in. x 6'8 in.	8'0 in. x 6'8 in.	8'0 in. x 8'0 in.	10'0 in. x 8'0 in.
61-1/2 in. x 80 in.	73-1/2 in. x 80 in.	97-1/2 in. x 80 in.	97-1/2 in. x 96 in.	121-1/2 in. x 96 in.

Call for quote on any size or options not shown



**Features**

- Overhead track w/plastic end caps
- Single cylinder hook lock w/lock guard
- Inside & outside handle pulls
- Surface mounted - 1 in. tabs
- 16 Ga. expanded metal (1/2 in.) on active door (option shown)
- Standard 24 Ga. perforated steel mesh for extra security is available as an upgrade for an additional charge

**Built to order**

- See page 18 for finishes
- Steel sliding patio security door can be ordered using most of our "Steel Security Door" designs and colors

\* **Inset mounting tabs not available**

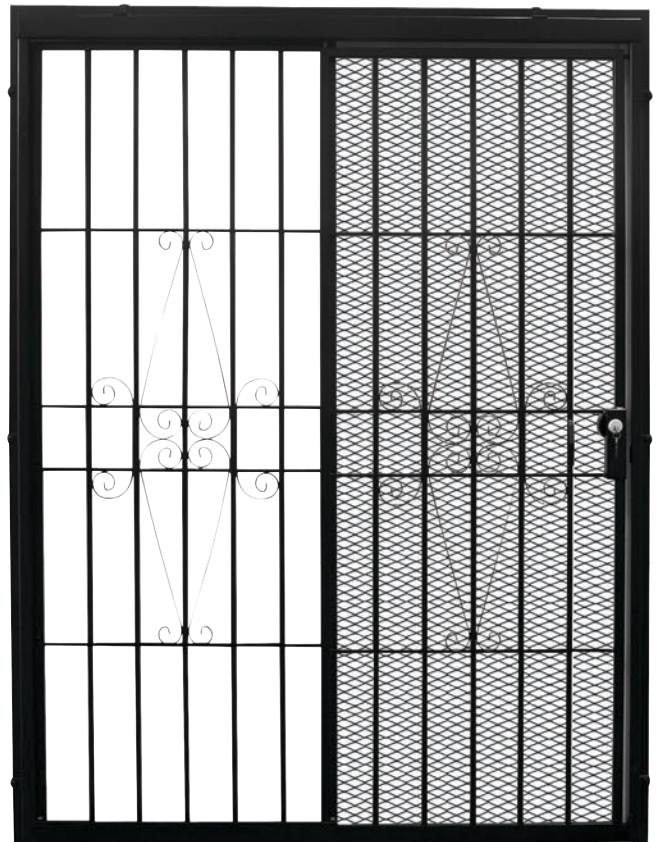
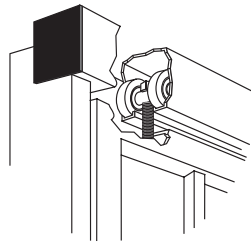

Up to:	Up to:	Up to:	Up to:	Up to:
5'0 in. x 6'8 in.	6'0 in. x 6'8 in.	8'0 in. x 6'8 in.	8'0 in. x 8'0 in.	10'0 in. x 8'0 in.
61-1/2 in. x 82-1/2 in.	73-1/2 in. x 82-1/2 in.	97-1/2 in. x 82-1/2 in.	97-1/2 in. x 98-1/2 in.	121-1/2 in. x 98-1/2 in.

Call for quote on any size or options not shown



Perforated



Expanded

Franciscan shown with contrasting mesh. Options shown have additional cost.



**Features**

- 1-1/2 in. sq. x 14 Ga. one piece frame
- 1 in. sq. x 16 Ga. steel door frame
- 5/8 in. sq. x 18 Ga. vertical steel pickets
- 3/8 in. sq. x 18 Ga. horizontal steel pickets
- 1/8 in. Thick x 1/2 in. wide steel scroll design
- Single hole lock-box w/ 2-1/8 in. bore & 2-3/8 in. backset
- Lock ring guard
- Continuous 1/8 in. x 1 in. "tamper guard" on strike, top, & frame
- Tamper proof hinges
- Standard 24 Ga. perforated steel mesh for extra security is available as an upgrade for an additional charge
- Optional 16 Ga. expanded metal (1/2 in.) on active door (as shown)
- Specify left or right side active door
- 1-1/2 in. Stand-off tabs standard
- Hinged at center
- Built to order
- See page 25 for finishes

Up to:	Up to:	Up to:	Up to:	Up to:
5'0 in. x 6'8 in.	6'0 in. x 6'8 in.	8'0 in. x 6'8 in.	8'0 in. x 8'0 in.	10'0 in. x 8'0 in.
61-1/2 in. x 82-1/2 in.	73-1/2 in. x 82-1/2 in.	97-1/2 in. x 82-1/2 in.	97-1/2 in. x 98-1/2 in.	121-1/2 in. x 98-1/2 in.

Call for quote on any size or options not shown



Perforated



Expanded



# STEEL PATIO DOORS & ENCLOSURES

Custom options (add-ons)

Product Line Z9999 for all options on this page

Option	Option Code	Description
<b>Mounting Variations</b> (Refer to Page 58)	OP-SurfaceMt	Surface mount (standard)
	OP-PDStndOffTab	Surface mount w/stand-off tabs (specify tab size)
	OP-PDSOTwStrap	Surface mount w/stand-off tabs & protective strap on lock side (specify tab size)
<b>Lock-Box</b>	OP-INSTL8560	Single hole lock-box
	OP-INSTL8559	Double hole lock-box
	OP-RingGuard	Ring guard - welded
	OP-HandlePull	Handle pull
	OP-SpecLBLoc	Special lock-box location
<b>Door Coverings</b>	OP-CONTPERFDD	Contrasting mesh option
	OP-24GaPerf2SD	24 Ga. perforated steel mesh w/ 3/32 in. dia holes (both sides)
	OP-16GaExpnd2SD	16 Ga. 1/2 in. expanded metal screen (both sides)
	OP-13GaExpnd2SD	13 Ga. 1/2 in. expanded metal screen (both sides)
	OP-24GaSolid2SD	24 Ga. solid sheet metal (both sides)
<b>Door designs</b>	OP-PDCarolina	Carolina style
	OP-PDDakota	Dakota style
	OP-PDGranada	Granada style
	OP-PDParadise	Paradise style (select insert)
	OP-PDImpression	Impressions style (select insert)
	OP-PDImperial	Imperial style
	OP-PDWoodguard	Woodguard style
	OP-PDClarion	Clarion style
	OP-PDSunburst	Sunburst style
	OP-PDLongevity	Longevity style (select insert)
	OP-PD Sonoma	Sonoma style
	OP-PDEnglishIvy	English Ivy style
	OP-PDItalianLeaf	Italian Leaf style
OP-PDFranciscan	Franciscan style	
<b>Centurion Enclosure</b>	OP-INSTL8560	Single hole lock-box
	OP-PDCUTOUT	Cut-out (buttresses)
	OP-PDSPCLDOOR	Special size door to 45 in. x 85-1/2 in.
<b>Steelmaster</b>	OP-BOTHACTIVE	Both doors operable
<b>Primer</b>	OP-Primerpaint	Primer undercoat + paint for extra rust protection

# WINDOW GUARDS

\*When installing window guards ALWAYS conform to local building codes.  
Precision will not assume liability pertaining to window guard usage/installation.

Series No.	Description
450	1/2" sq. Tubular pickets (4" extension) 5/8" sq. Horizontal bars Apache spear point top & bottom All mounting hardware sold separately Special order for all sizes and colors.



Note: always measure width x height in ft.- in.

All other colors: Almond (AL), bronze (BZ), or white (WH) are only available.

To order in a color other than black, replace the BK in the sample part numbers listed in the table below with the abbreviation of the desired color.

		Width								
		1'6"	2'0"	2'6"	3'0"	3'6"	4'0"	4'6"	5'0"	6'0"
Height	1'6"	450BK1616	450BK2016	450BK2616	450BK3016	450BK3616	450BK4016	450BK4616	450BK5016	450BK6016
	2'0"	450BK1620	450BK2020	450BK2620	450BK3020	450BK3620	450BK4020	450BK4620	450BK5020	450BK6020
	2'6"	450BK1626	450BK2026	450BK2626	450BK3026	450BK3626	450BK4026	450BK4626	450BK5026	450BK6026
	3'0"	450BK1630	450BK2030	450BK2630	450BK3030	450BK3630	450BK4030	450BK4630	450BK5030	450BK6030
	3'6"	450BK1636	450BK2036	450BK2636	450BK3036	450BK3636	450BK4036	450BK4636	450BK5036	450BK6036
	4'0"	450BK1640	450BK2040	450BK2640	450BK3040	450BK3640	450BK4040	450BK4640	450BK5040	450BK6040
	4'6"	450BK1646	450BK2046	450BK2646	450BK3046	450BK3646	450BK4046	450BK4646	450BK5046	450BK6046
	5'0"	450BK1650	450BK2050	450BK2650	450BK3050	450BK3650	450BK4050	450BK4650	450BK5050	450BK6050
	6'0"	450BK1660	450BK2060	450BK2660	450BK3060	450BK3660	450BK4060	450BK4660	450BK5060	450BK6060

For Series 450:

4'6" wide and larger window guards have additional top and bottom locations for center brackets and if used will require **2 additional brackets (part #8103-PK)**.

4'6" high and larger window guards have additional horizontal cross bar and if used will require **2 additional brackets (part #8103-PK)**.

Window guards beyond 5'0" wide have 2 horizontal scroll patterns. Window guards less than 2'0" in any dimension have modified scroll work.

Series No.	Description
460	5/8" sq. Tubular pickets (4" extension) 5/8" sq. Horizontal bars Apache spear point top & bottom All mounting hardware sold separately Special order for all sizes and colors



Note: always measure width x height in ft.- in.

Determine the correct part number to order using the following sample number: **460BK3036**

**460** = window guard series; **BK** = color (black); **30** = width in feet & inches (3'0"); **36** = height in feet & inches (3'6")

**Available colors:** Almond (AL), black (BK), bronze (BZ), or white (WH)

**Standard widths:** 1'6", 2'0", 2'6", 3'0", 3'6", 4'0", 4'6", 5'0", 6'0" & 8'0" | **Standard heights:** 1'6", 2'0", 2'6", 3'0", 3'6", 4'0", 4'6", 5'0" & 6'0"

For Series 460:

4'6" wide and larger window guards have additional top and bottom locations for center brackets and if used will require **2 additional brackets (part #8103-PK)**.

4'6" high and larger window guards have additional horizontal cross bar and if used will require **2 additional brackets (part #8103-PK)**.

Window guards beyond 5'0" wide have 2 horizontal scroll patterns. Window guards less than 2'0" in any dimension have modified scroll work.

Series No.	Description
455	1/2" sq. Solid steel pickets 5/8" sq. Horizontal bars Square cut ends top & bottom All mounting hardware sold separately Special order for all sizes and colors



Note: always measure width x height in ft.- in.

Determine the correct part number to order using the following sample number: **455BK3036**

**455** = window guard series; **BK** = color (black); **30** = width in feet & inches (3'0"); **36** = height in feet & inches (3'6")

**Available colors:** Almond (AL), black (BK), bronze (BZ), or white (WH)

**Standard widths:** 1'6", 2'0", 2'6", 3'0", 3'6", 4'0", 4'6", 5'0", 6'0" & 8'0" | **Standard heights:** 1'6", 2'0", 2'6", 3'0", 3'6", 4'0", 4'6", 5'0" & 6'0"

For Series 455:

4'6" wide and larger window guards have additional top and bottom locations for center brackets and if used will require **2 additional brackets (part #8103-PK)**.

4'6" high and larger window guards have additional horizontal cross bar and if used will require **2 additional brackets (part #8103-PK)**.

Window guards beyond 5'0" wide have 2 horizontal scroll patterns. Window guards less than 2'0" in any dimension have modified scroll work.



Series No.	Description
------------	-------------

465  
 Product Line:  
**G3811**  
 1/2" sq. Tubular pickets (4" extension)  
 5/8" sq. Frame  
 Single arch  
 All mounting hardware sold separately  
 Special order for all sizes and colors

Note: always measure width x height in ft.- in.

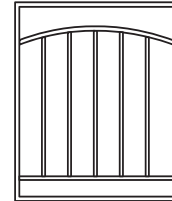

Determine the correct part number to order using the following sample number: **465BK3036**

**465** = window guard series; **BK** = color (black); **30** = width in feet & inches (3'0"); **36** = height in feet & inches (3'6")

**Available colors:** Almond (AL), black (BK), bronze (BZ), or white (WH)

**Standard widths:** 1'6", 2'0", 2'6", 3'0", 3'6", 4'0", 4'6", 5'0", 6'0" & 8'0" | **Standard heights:** 1'6", 2'0", 2'6", 3'0", 3'6", 4'0", 4'6", 5'0" & 6'0"

**For Series 465:**

**4'6" wide and larger** window guards have additional top and bottom locations for center brackets and if used will require **2 additional brackets (part #8103-PK).**

**4'6" high and larger** window guards have additional horizontal cross bar and if used will require **2 additional brackets (part #8103-PK).**

Window guards beyond 5'0" wide have 2 horizontal scroll patterns. Window guards less than 2'0" in any dimension have modified scroll work.

Series No.	Description
------------	-------------

470  
 Product Line:  
**G3811**  
 1/2" sq. Square tubular pickets  
 5/8" sq. Frame  
 "S" and "C" scrolls  
 All mounting hardware sold separately  
 Special order for all sizes and colors

Note: always measure width x height in ft.- in.

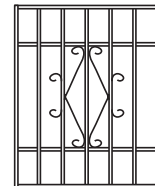

Determine the correct part number to order using the following sample number: **470BK3036**

**470** = window guard series; **BK** = color (black); **30** = width in feet & inches (3'0"); **36** = height in feet & inches (3'6")

**Available colors:** Almond (AL), black (BK), bronze (BZ), or white (WH)

**Standard widths:** 1'6", 2'0", 2'6", 3'0", 3'6", 4'0", 4'6", 5'0", 6'0" & 8'0" | **Standard heights:** 1'6", 2'0", 2'6", 3'0", 3'6", 4'0", 4'6", 5'0" & 6'0"

**For Series 470:**

**4'6" wide and larger** window guards have additional top and bottom locations for center brackets and if used will require **2 additional brackets (part #8103-PK).**

**4'6" high and larger** window guards have additional horizontal cross bar and if used will require **2 additional brackets (part #8103-PK).**

Window guards beyond 5'0" wide have 2 horizontal scroll patterns. Window guards less than 2'0" in any dimension have modified scroll work.

# CUSTOM WINDOW GUARD APPLICATIONS

(Product Line: Z9999)

\*When installing window guards ALWAYS conform to local building codes. Precision will not assume liability pertaining to window guard usage/installation.

Add to the price of a standard (or custom size) window guard. Mounting brackets shown for clarity and are **not** included.

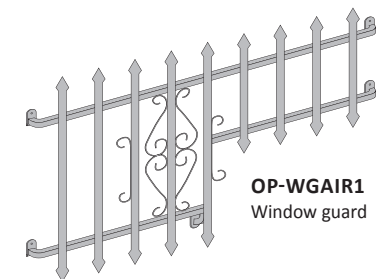

**AIR CONDITIONER CUT-OUT**

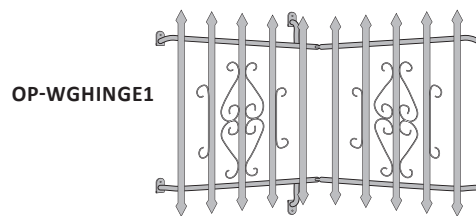

**HINGED WINDOW GUARD**

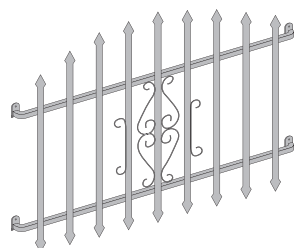

**ARCHED PICKETS**

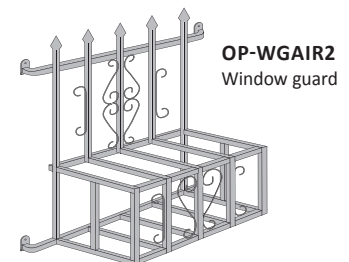
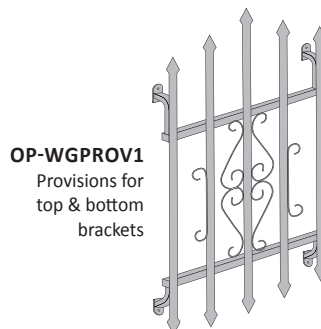

**AIR CONDITIONER CAGE**

# WINDOW GUARD ACCESSORIES

Part No.	Product Line	Description
<b>Window guard brackets</b> <i>All brackets stocked in white and black. Adobe, almond and bronze are made to order</i>		
8100	G8100	3 in. Standard offset window guard bracket kit Pack consists of: 2 left hand, 2 right hand brackets and 4 each 5/16 in. x 3 in. one way lag screws.
8103	G8100	3 in. Standard center window guard bracket kit Pack consists of: 2 center brackets and 2 each 5/16 in. x 3 in. one way lag screws.
8106	G8100	Straight window guard bracket kit Pack consists of: 4 straight brackets and 4 each 5/16 in. x 3 in. one way lag screws.
8109	G8100	Flush window guard bracket kit Pack consists of: 2 left hand, 2 right hand flush brackets and 4 each 5/16 in. x 3 in. one way lag screws.
8111	G8100	Flush center - black (4 per) w/screws Pack consists of: 2 flush center guard brackets and 4 each 5/16 in. x 3 in. one way lag screws.
8113	G8100	1 in. Offset window guard bracket kit Pack consists of: 2 left hand and 2 right hand brackets and 4 each 5/16 in. x 3 in. one way lag screws.
8115	G8100	6 in. Offset window guard bracket kit Pack consists of: 2 left hand and 2 right hand brackets and 4 each 5/16 in. x 3 in. one way lag screws.
8116	G8100	Hinged center bracket Poly bag of 1 each; available in black.
8118	G8100	"T" bracket window guard kit Pack consists of: 2 "T" brackets and 2 each 5/16 in. x 3 in. one way lag screws.
8119	G8100	3 in. x 12 in. Offset window guard bracket kit
<b>Hardware</b>		
8117	G8100	Fire release hinge bracket kit Pack consists of: 1 fire release bracket and 1 each 5/16 in. x 3 in. one way lag screws; available in almond, black and white.
8124	G8100	Fire release shielded cable kit Order lag screws separately; available in black and white.

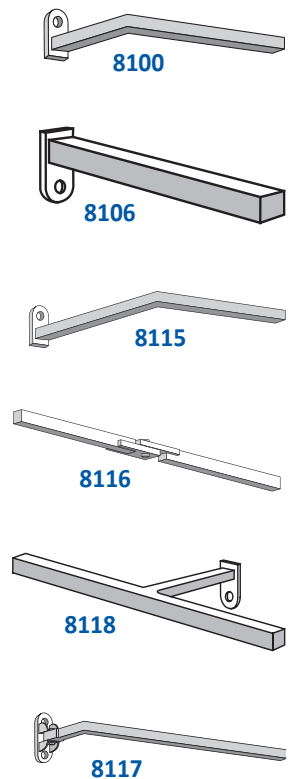

Part No.	Product Line	Pack QTY	Description
<b>Tools</b>			
8950	G8100	1	One way driving tool
8951	G8100	1	Adapter, used for 1/2 in. square drive
<b>Fasteners</b> <i>Available in adobe, almond, black, bronze and white</i>			
8130-2-4PK	G8100	4	5/16 in. x 2 in. lag screws
8130-3-4PK	G8100	4	5/16 in. x 3 in. lag screws
8130-4-4PK	G8100	4	5/16 in. x 4 in. lag screws
8130-2-100PK	G8100	100	5/16 in. x 2 in. lag screws
8130-3-100PK	G8100	100	5/16 in. x 3 in. lag screws

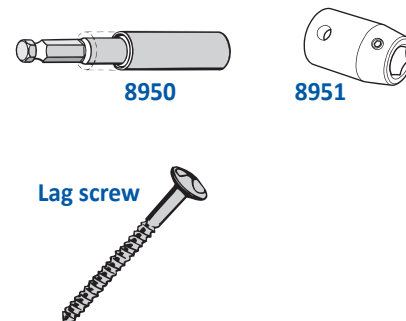

\*Sample number for fasteners: **8130AD3-4PK** for a pack of 4 adobe colored 3 in. lag screws

## SECURITY MESH GUARD

Part No.	Product Line	Description
DG30	G3813	23-1/4 in. x 43 in., Fits 30 in. door
DG32	G3813	25-1/4 in. x 43 in., Fits 32 in. door
DG36	G3813	29-1/4 in. x 43 in., Fits 36 in. door

### Security mesh guard features:

- Tamper-proof
- Strong 16 gauge expanded metal
- 1 in. angle - steel frame
- Black powder coat standard
- Complete with tabs and four 1 in. one-way screws

## MESH GUARD OPTIONS

Part No.	Product Line	Description
DG11	—	Stand-off tabs - additional
DG100	G3813	1/2 in. Expanded metal (16 ga.)
DG200	G3813	Perforated metal (24 ga.)
DG300	G3813	Solid metal (24 ga.)

# SECURITY DOOR MOUNTING VARIATIONS

## SURFACE MOUNT

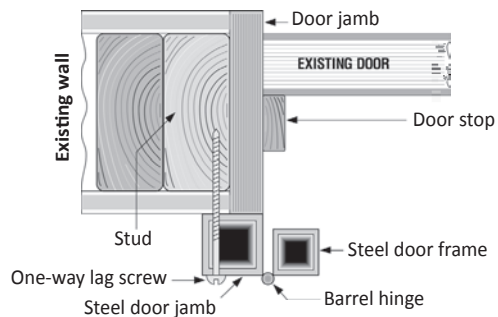

**Surface mount standard**

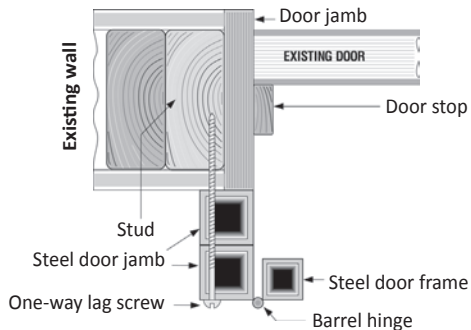

**Surface mount w/tube backing**

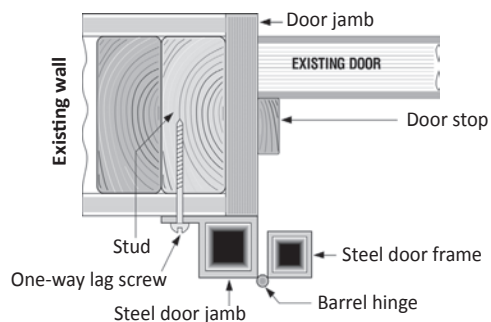

**Surface mount w/tabs**

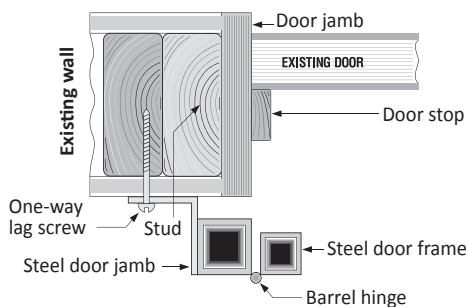

**Surface mount w/stand-off tabs**

## INSET MOUNT

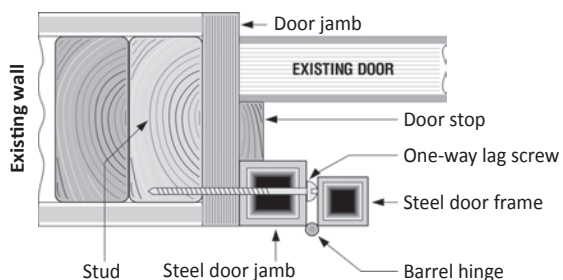

**Inset mount**

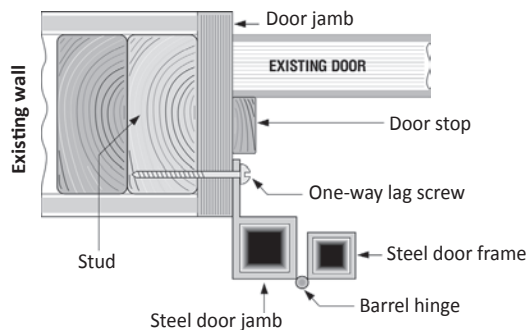

**Inset mount w/tab**

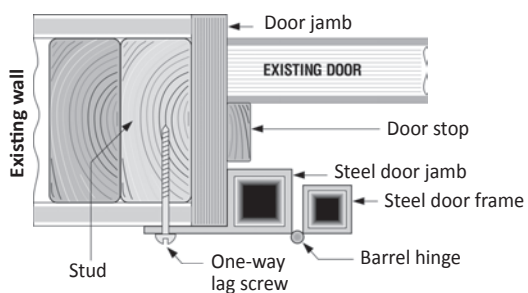

**Inset mount w/surface tabs**

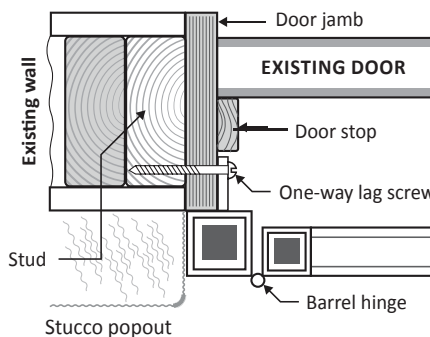

**Inset mount w/ tab (Special tab placement)**



**Step 1: Determine Door Width**

Measure the opening "Width" between the left and right door jambs as seen in (Diagram A).

Record Opening "Width" Here: \_\_\_\_\_ "

(See page 4 of this worksheet for mounting options)

**FOR SURFACE MOUNT**

Then add 3 in. to arrive at the finished door width: \_\_\_\_\_ "

(Add 3-1/2 in. for Steel Master, English Ivy, Italian Leaf, & Sonoma Doors)

**FOR INSET MOUNT**

Then subtract 1/4 in. to arrive at the finished door width: \_\_\_\_\_ "

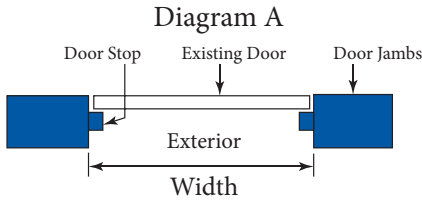

**Step 2: Determine Door Height**

Measure the opening "Height" from the bottom of door header to the top of the threshold as seen in (Diagram B).

Record Opening "Height" Here: \_\_\_\_\_ "

Diagram B

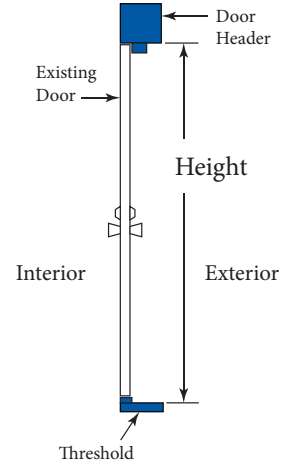

For a three (3) sided frame

**FOR SURFACE MOUNT**

Add 1-3/4 in. to arrive at the finished door height: \_\_\_\_\_ "  
(Add 2 in. for Steel Master, English Ivy, Italian Leaf, & Sonoma Doors)

**FOR INSET MOUNT**

Subtract 1/4 in. to arrive at the finished door height: \_\_\_\_\_ "

For a four (4) sided frame

**FOR SURFACE MOUNT**

Add 3 in. to arrive at the finished door height: \_\_\_\_\_ "  
(Add 3-1/2 in. for Steel Master, English Ivy, Italian Leaf, & Sonoma Doors)

**FOR INSET MOUNT**

Subtract 1/4 in. to arrive at the finished door height: \_\_\_\_\_ "

**Step 3: Determine Hinge Side**

Specify placement as either "Left (or) Right Hand" hinged as viewed from the outside of the door looking in as seen in (Diagram C).

Left Hand Hinge **OR**  Right Hand Hinge

Diagram C

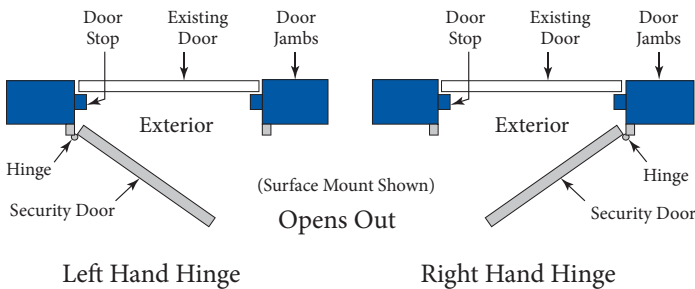

**Step 4: Determine Lockbox Height**

Measure from bottom of the door to center of the "Lockbox" as seen in (Diagram D).

Record "Lockbox" Height Here: \_\_\_\_\_

Note: "Lockbox" will be "centered" if Lockbox height is "not" specified.

Diagram D

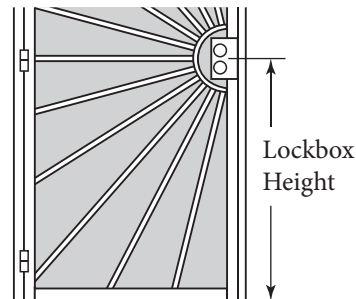

**Step 5:** Complete the following three (3) page order form and send it to our Precision customer service team.

**Color:**



Door

Mesh

**Primer:**  Double Coat  
 High Zinc Primer

Single Color Door  
(Mesh to Match Door/Frame - Standard)

Contrasting Mesh (Two Tone)

**Mesh Options:**

- 24 Ga. Perf (Standard)
- 1/2 in. Expanded (16 Ga.)
- Hex Perf with screen (22 Ga.)
- Hex Perf with screen (16 Ga.)
- Stainless Steel Mesh (Black Only)
- No Covering



24 Ga. Perforated

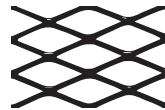

16 Ga. 1/2 in. Expanded



Hex Perf

Hex Perf door covers allow for high air flow and improved visibility.

**Handing:** Single Door (Viewed from the outside looking in)

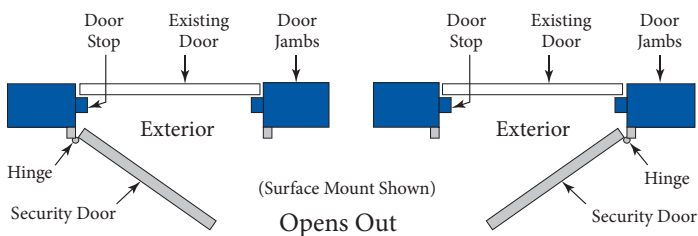

Left Hand Hinge  Left Hand Hinge

Right Hand Hinge  Right Hand Hinge

**Active Door:** Double Door (Viewed from the outside looking in)

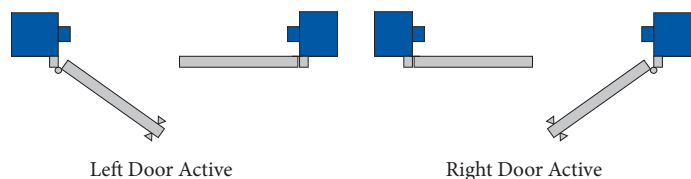

Left Door Active  Right Door Active

Cane Bolts  Flush Extension Bolts

**Lock-Box:**

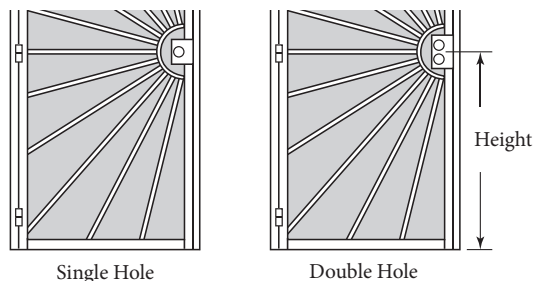

Double Hole (Standard)

Single Hole

Distance from Bottom of Door to Center of Lock-Box: \_\_\_\_\_  
(Lock-Box at Center - Standard)

**Frame:**

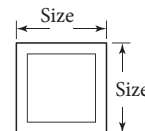

- 1-1/4 in. square (3) Piece (Standard)
- 1-1/4 in. square One Piece Welded Frame (3) Sided
- 1-1/4 in. square One Piece Welded Frame (4) Sided
- 1-1/2 in. square One Piece Welded Frame (3) Sided  
(Standard on: Steel Master, English Ivy, Italian Leaf, & Sonoma)
- 1-1/2 in. square One Piece Welded Frame (4) Sided

## Mounting:

- Surface (Standard)
- Inset
- Inset with Tabs
- Surface with Tabs
- Inset with Surface Tabs
- Inset with Tabs (Special tab placement)

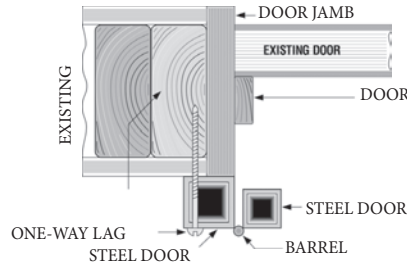

**SURFACE MOUNT (STAN-**

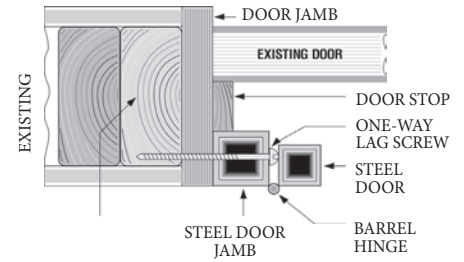

**INSET**

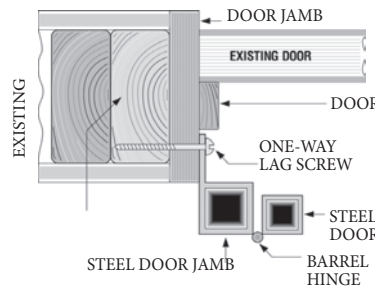

**INSET MOUNT W/**

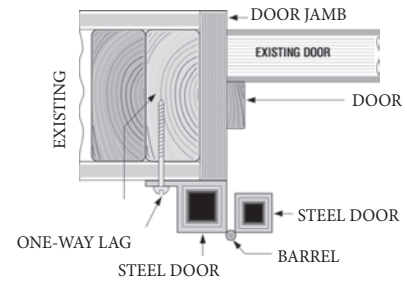

**SURFACE MOUNT W/TABS**

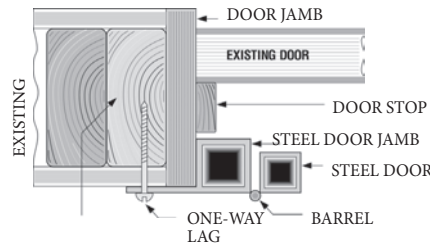

**INSET MOUNT W/SURFACE**

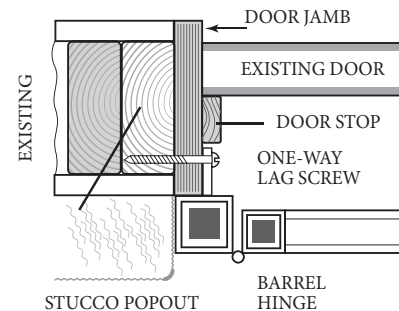

**INSET MOUNT W/ TAB  
(SPECIAL TAB PLACEMENT)**

## 4 SIDED FRAME OPTION

Please note: Some applications will require the new door to have a section of frame at the bottom of the door. When you order a steel security door with the 4-sided frame option, the overall height will be 1-1/2 in. larger do to the added frame at the bottom.

I.E. 3-1/2 in. to the width and 3-1/2 in. to the height

Example - See Longevity door on page 27.



# PRECISION SCREEN & SECURITY PRODUCTS

## PRO STEEL SECURITY DOOR WORKSHEET

<b>Door Model:</b> _____			<b>Customer:</b> _____		
Size: _____ Width x _____ Height			<b>P.O.:</b> _____		
Net Frame (Overall Width x Overall Height)			<b>Date:</b> _____		
<b>Color:</b>		<b>Door</b>	<b>Mesh</b>	<b>Frame:</b>	
	Black				1-1/4" sq. (3) Piece (Std.)
	White				1-1/4" sq. One Piece (3) Sided
	Bronze				1-1/4" sq. One Piece (4) Sided
	Almond				1-1/2" sq. (3) Piece
	Adobe				1-1/2" sq. One Piece (3) Sided
	Weathered Brown				1-1/2" sq. One Piece (4) Sided
	Textured Black			<b>Mounting:</b>	Surface Mount (Std.)
	Textured White				Inset Mount
<b>Primer:</b>	Double Coat				Inset Mount w/Tabs
	High Zinc Primer				Inset Mount w/Offset Tabs
<b>Door Cover:</b>	24 Ga. Perf (Standard)				Surface Mount w/Tabs
	1/2" Expanded (16 Ga.)				Inset Mount w/Surface Tabs
	No Covering				Surface Mount w/Stand-off Tabs
	Stainless Steel Mesh (Black Only)				Tab Length (1 in., 1-1/2 in., 2 in., 3 in.)
	Hex Perf w/Screen (22 Ga.)				Surface Mount Tube Backing
	Hex Perf w/Screen (16 Ga.)				Inset Mount w/Full Strapping
	1/2" Expanded (13 Ga.)				Strapping Width (1-1/2 in., 2 in., 3 in. 4 in.)
	Solid Sheet (24 Ga.)			<b>Center Insert Designs:</b>	Cactus
<b>Handing:</b>	Right Hand Hinge			(Impressions)	Coyote
Single Door	Left Hand Hinge			(Longevity)	Deer scene
(Outside Looking In)	Opens Out			(Paradise)	Dolphins
	Opens In			(Vineyard)	Gecko
<b>Active Door:</b>	Right Door Active				Horse
Double Door	Left Door Active				Hummingbird
(Outside Looking In)	Flush Extension Bolts				Longevity
	Cane Bolts				Love birds
	Flush Top - Cane Bottom				Palm tree
<b>Lock-Box:</b>	Double Hole (Standard)				Welcome
	Single Hole			<b>Water-Jet Door Designs:</b>	Whale tail
	Ring Guard				For Water-Jet Designs Refer to Pages #24 & #25
	Distance from Bottom of Door to Center of Lock-Box (Lock-Box at Center - Standard)				
<b>Special Instructions:</b>				<b>Mail Slot:</b>	Mail Slot w/No Cover
					Mail Slot w/Cover
				Mail Slot Location:	

PRODUCT	PAGE
Economy steel security doors.....	62-65

## ECONOMY STEEL SECURITY DOORS

This section includes photographs and specifications of Precision’s line of economy steel security doors. Although these products are not manufactured at our Lynwood, CA facility, all items are welded, assembled and finished using high quality raw materials and are designed and priced to allow your customers the option of purchasing a quality, reasonably priced door.

For applications where finish, special options and custom features are critical, please go to section 2 of this catalog where our Precision made to order domestic steel security doors are shown.

Our economy line of steel security doors have a 90 day limited warranty against functional manufacturing defects only. Cosmetic defects do affect the applications and uses for which this door is designed. Due to these doors being a lower cost option to our domestic line of steel security doors, we cannot accept any returns or credits for cosmetic issues.

Only the standard sizes and colors shown are available on the Precision economy line of steel security doors.

### Standard “net” frame sizes

Standard “net” sizes shown indicate the typical “call-out” size plus the outside mounting frame. Please keep these dimensions in mind when ordering. If a standard sized door will not fit the opening measurements, please go to section 2, where “custom” sized product may be ordered.

Precision economy steel security doors come as **surface mount**.

The **standard sizes** indicated in this section represent “industry standard” door openings.

NO CUSTOM SIZES - for Custom Sizes refer to the Domestic Steel Section.

**Economy steel security door** dimensions for the Regal:

A. The net overall size, which includes the 3-piece mounting frame, is as follows:

Door Opening	Net Overall Size
2'8 in. x 6'8 in. (32 in. x 80 in.)	2'10-1/2 in. x 6'9-1/2 in. (34-1/2 in. x 81-1/2 in.)
3'0 in. x 6'8 in. (36 in. x 80 in.)	3'2-1/2 in. x 6'9-1/2 in. (38-1/2 in. x 81-1/2 in.)

**Economy steel security door** dimensions for the Flagstaff, Del Sol, & Monterrey:

A. The net overall size, which includes the 3-piece mounting frame, is as follows:

Door Opening	Net Overall Size
3'0 in. x 6'8 in. (36 in. x 80 in.)	3'3 in. x 6'9-3/4 in. (39 in. x 81-3/4 in.)

On products with perforated metal that is welded in place, the perforated metal may experience deformation and the item may have areas of insufficient finish.

To prevent oxidation (rust), touch up any scratches, chips, etc. with a quality rust inhibiting paint as soon as possible. In order to maintain a rust free finish, regularly inspect and re-paint as needed. In exposed, damp or coastal areas annual painting is recommended.

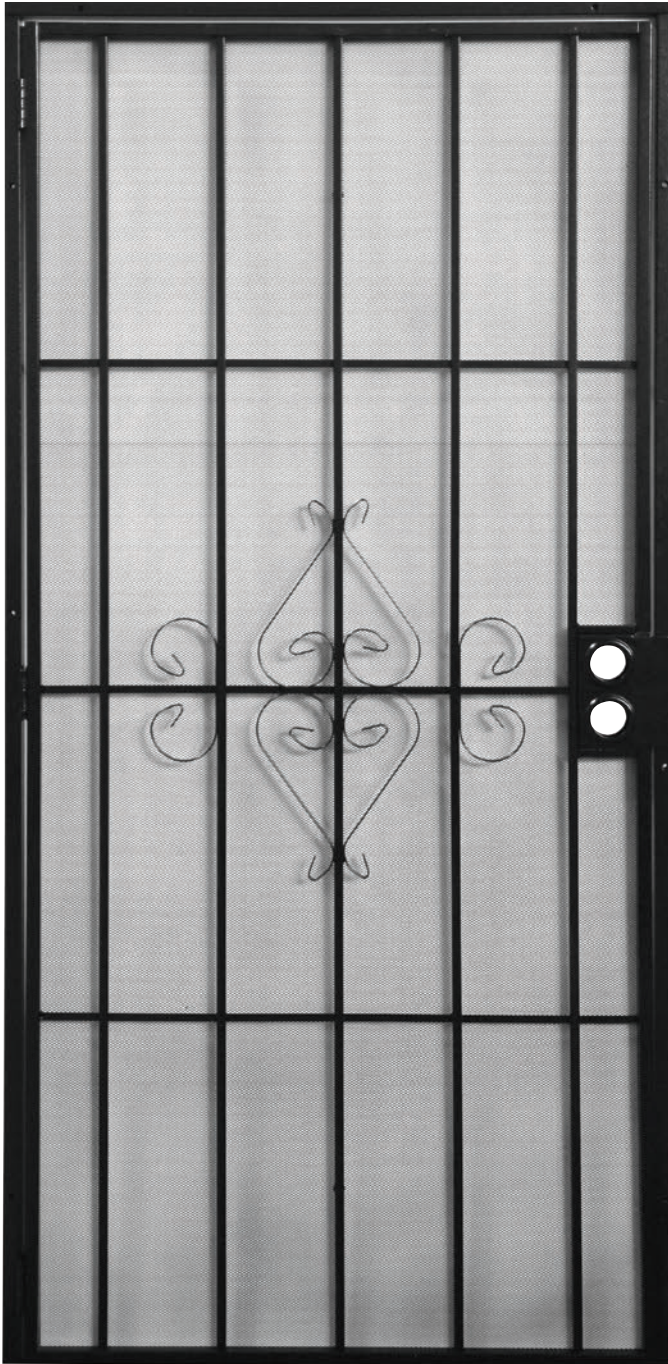

#### Features

- Standard sizes only - No custom sizes  
2'8 in. x 6'8 in. (34-1/2 in. x 81-1/2 in.)  
3'0 in. x 6'8 in. (38-1/2 in. x 81-1/2 in.)
- 1 in. sq. x 18 Ga. 3-piece steel mounting frame
- 3/4 in. sq. x 18 Ga. steel door frame
- 1/2 in. sq. x 18 Ga. vertical steel pickets
- 1/2 in. Flat bar horizontal steel pickets
- 1/8 in. Thick x 1/2 in. wide steel scroll design
- Double hole lock-box w/ 2-1/8 in. bore & 2-3/8 in. backset
- Tamper-proof hinges
- 24 Ga. expanded steel mesh for extra security
- Non-handed

#### Standard Finishes

- Black or white finish with matching expanded steel mesh
- No other color options available for this door

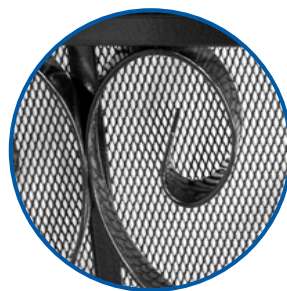



**Features**

- Standard size only - No custom sizes  
3'0 in. x 6'8 in. (39 in. x 81-3/4 in.)  
**3'0 in. x 8'0 in. (39 in. x 97-3/4 in.)**
- 1 in. x 1-1/2 in. x 18 Ga. pre-hung steel mounting frame
- 1 in. sq. x 18 Ga. steel door frame
- 1/2 in. sq. x 18 Ga. vertical pickets
- 3/4 in. sq. x 18 Ga. horizontal pickets
- Double hole lock-box w/ 2-1/8 in. bore & 2-3/8 in. backset
- Continuous 1/8 in. x 3/4 in. steel lock side "tamper guard"
- Tamper-proof hinges
- 24 Ga. expanded steel mesh for extra security
- Non-handed

**Standard Finishes**

- Black or white finish with matching expanded steel mesh
- No other color options available for this door

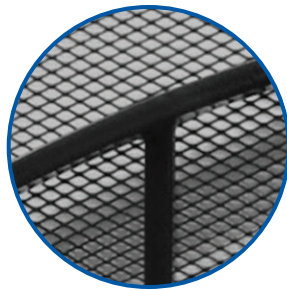



#### Features

- Standard sizes only - No custom sizes  
3'0 in. x 6'8 in. (39 in. x 81-3/4 in.)
- 1-1/4 in. sq. x 18 Ga. 3-piece steel mounting frame
- 1 in. x 2 in. x 18 Ga. steel door frame
- 1/2 in. sq. x 18 Ga. steel pickets
- Double hole lock-box w/ 2-1/8 in. bore & 2-3/8 in. backset
- Tamper-proof hinges
- 24 Ga. perforated steel mesh for extra security
- Non-handed

#### Standard Finishes

- Almond, black or white finish with matching perforated steel mesh
- No other color options available for this door

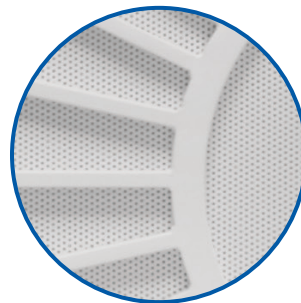



**Features**

- Standard size only - No custom sizes  
3'0 in. x 6'8 in. (39 in. x 81-3/4 in.)
- 1-1/4 in. sq. x 18 Ga. 3-piece steel mounting frame
- 1 in. sq. x 18 Ga. steel door frame
- 1/2 in. sq. x 18 Ga. vertical steel pickets
- 1/2 in. sq. x 18 Ga. horizontal steel pickets
- Two signature aluminum castings
- Double hole lock-box w/ 2-1/8 in. bore & 2-3/8 in. backset
- Tamper-proof hinges
- 24 Ga. perforated steel mesh for extra security
- Non-handed

**Standard Finishes**

- Black, bronze or white finish with matching perforated steel mesh
- No other color options available for this door

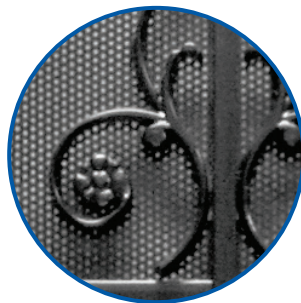
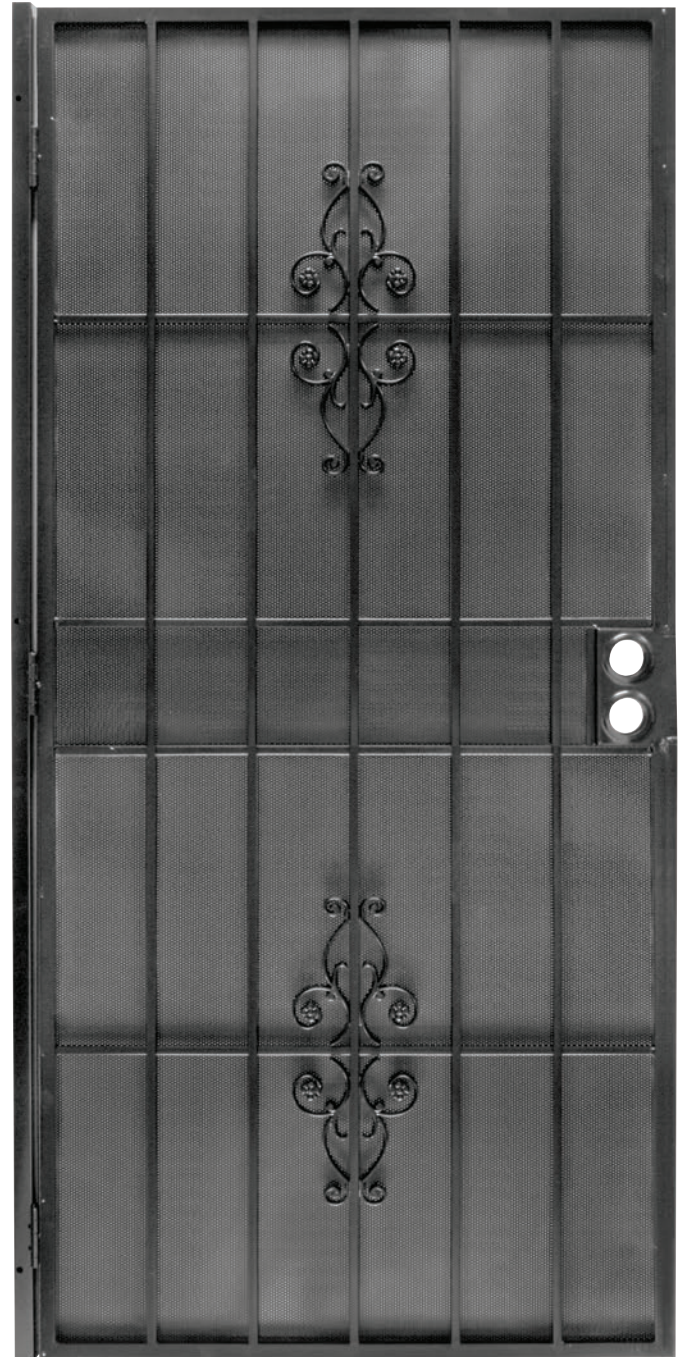



# SECTION 4 / SLIDING SCREEN DOORS

PRODUCT	PAGE
Aluminum roll form sliding screen door (assembled / KD).....	67
Extruded aluminum sliding screen doors (assembled / KD).....	68-72
Custom options for sliding screen doors (assembled / KD).....	73-74
Sliding screen channels and astragals .....	75
Sliding screen door measuring worksheet .....	76
Sliding screen door order form.....	77

Roll Form Aluminum  
Screen Door

**Features**

- 1-5/8 in. Roll form aluminum frame
- Black plastic Anjac handle assembly with strike plate & installation screws
- Non-handed with handle centered
- Extruded Aluminum spur corners
- Charcoal fiberglass insect screening (on assembled doors)
- 1 in. Steel ball bearing spring tension roller with adjustment screw (plastic inserts are no longer standard)
- Extruded vinyl bug seal with flap & tear-off strips
- Assembled & K.D. widths available up to 61 in.
- Assembled & K.D. heights available up to 97 in. (specify handle height on doors over 84 in. tall)

**Standard Finishes**

- Bronze, gray or white powder coated



Call for quote on any sizes or options not shown

**3100 (Assembled)**  
Product Line: D3301

Door size up to

37 in. x 81 in.	37 in. x 97 in.
49 in. x 81 in.	49 in. x 97 in.
61 in. x 81 in.	61 in. x 97 in.

**4100 (KD) \***

Product Line: D3310

Door size up to

31 in. x 81 in.	31 in. x 97 in.
37 in. x 81 in.	37 in. x 97 in.
49 in. x 81 in.	49 in. x 97 in.
61 in. x 81 in.	61 in. x 97 in.



For KD kits - Convenient six pack packaging:

Deduct \$2.00 per door (subject to discount)

\*All rails are miter cut

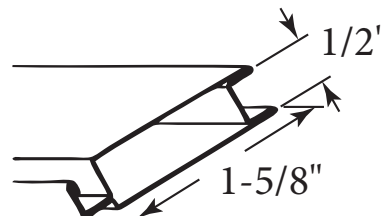
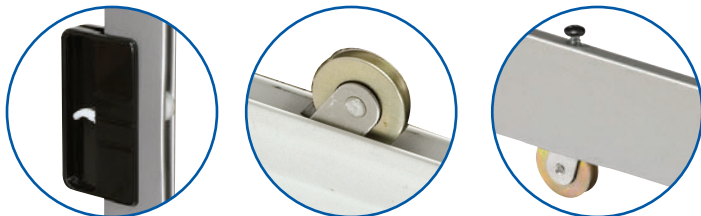

### Product Line - D3301/D3311

#### Extruded Aluminum Screen Door



With optional pet door installed

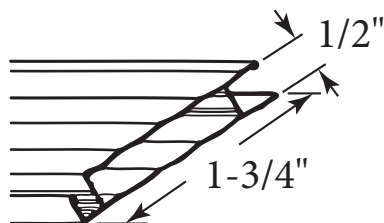

#### Features

- 1-3/4 in. .050 Extruded aluminum frame (fluted)
- Extruded aluminum handle assembly with mortise lock & lever latch
- Non-handed with handle centered
- Extruded aluminum spur corners
- Charcoal fiberglass insect screening (on assembled doors)
- 1 in. Steel ball bearing spring tension roller with adjustment screw (plastic inserts are no longer standard)
- Extruded vinyl bug seal with flap & tear-off strips
- Assembled & K.D. widths available up to 73 in.
- Assembled & K.D. heights available up to 110 in. (specify handle height on doors over 84 in. tall)  
**Extra charges will apply for doors over 97 in. in height**
- Pet door and pet grille available

#### Standard Finishes

- Adobe, almond, black, bronze or white powder coated
- Bronze and satin anodized

Call for quote on any sizes or options not shown

#### 3200 (Assembled) Product Line: D3302

Door size up to*		
37 in. x 81 in.	37 in. x 97 in.	37 in. x 110 in.
49 in. x 81 in.	49 in. x 97 in.	49 in. x 110 in.
61 in. x 81 in.	61 in. x 97 in.	61 in. x 110 in.
73 in. x 81 in.	73 in. x 97 in.	73 in. x 110 in.

\*Doors over 97 in. tall are subject to an additional charge

#### 4200 (KD) \*\* Product Line: D3311

Door size up to*		
31 in. x 81 in.	31 in. x 97 in.	31 in. x 110 in.
37 in. x 81 in.	37 in. x 97 in.	37 in. x 110 in.
49 in. x 81 in.	49 in. x 97 in.	49 in. x 110 in.
61 in. x 81 in.	61 in. x 97 in.	61 in. x 110 in.

For KD kits - Convenient six pack packaging:  
Deduct \$2.00 per door (subject to discount)

\*\*Miter cut service available for an additional charge

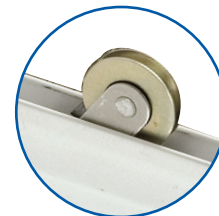



Extruded Aluminum  
Screen Door

**Features**

- 1-3/4 in. .050 Extruded aluminum frame
- Extruded aluminum handle assembly with mortise lock & lever latch
- Non-handed with handle centered
- Heavy duty diecast corners with side adjustment
- Charcoal fiberglass insect screening (on assembled doors)
- 1-1/4 in. Steel ball bearing rollers
- Extruded vinyl bug seal with flap & tear-off strips
- Assembled & K.D. widths available up to 73 in.
- Assembled & K.D. heights available up to 110 in. (specify handle height on doors over 84 in. tall)  
**Extra charges will apply for doors over 97 in. in height**
- Pet door and pet grille available

**Standard Finishes**

- Adobe, almond, black, bronze or white powder coated
- Bronze or satin anodized

Call for quote on any sizes or options not shown

**3300 (Assembled)**  
Product Line: D3302

Door size up to\*

37 in. x 81 in.	37 in. x 97 in.	37 in. x 110 in.
49 in. x 81 in.	49 in. x 97 in.	49 in. x 110 in.
61 in. x 81 in.	61 in. x 97 in.	61 in. x 110 in.
73 in. x 81 in.	73 in. x 97 in.	73 in. x 110 in.

\*Doors over 97 in. tall are subject to an additional charge

**4300 (KD) \*\***  
Product Line: D3311

Door size up to\*

31 in. x 81 in.	31 in. x 97 in.	31 in. x 110 in.
37 in. x 81 in.	37 in. x 97 in.	37 in. x 110 in.
49 in. x 81 in.	49 in. x 97 in.	49 in. x 110 in.
61 in. x 81 in.	61 in. x 97 in.	61 in. x 110 in.

For KD kits - **Convenient six pack packaging:**  
Deduct \$2.00 per door (subject to discount)

\*\*Miter cut service available for an additional charge

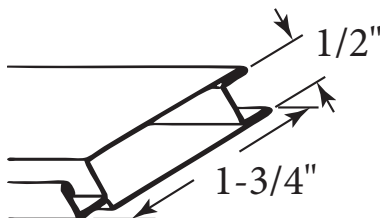
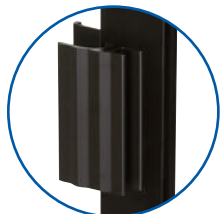

### Product Line - D3302/D3312

#### Extruded Aluminum Screen Door



#### Features

- 2-1/2 in. .060 Extruded aluminum frame (fluted)
- Extruded aluminum handle assembly with mortise lock & lever latch
- Extruded aluminum spur corners
- Charcoal fiberglass insect screening (on assembled doors)
- 1 in. Steel ball bearing spring tension top rollers
- 1-1/4 in. Steel ball bearing bottom rollers
- Extruded vinyl bug seal with flap & tear-off strips
- **Specify handing: latch side, left or right as viewed from outside looking in**
- Assembled & K.D. widths available up to 73 in.
- Assembled & K.D. heights available up to 110 in. (specify handle height on doors over 84 in. tall)  
**Extra charges will apply for doors over 97 in. in height**
- Pet door and pet grille available

#### Standard Finishes

- Adobe, almond, black, bronze or white powder coated
- Bronze or satin anodized

Call for quote on any sizes or options not shown

#### 3400 (Assembled) Product Line: D3302

##### Door size up to\*

37 in. x 81 in.	37 in. x 97 in.	37 in. x 110 in.
49 in. x 81 in.	49 in. x 97 in.	49 in. x 110 in.
61 in. x 81 in.	61 in. x 97 in.	61 in. x 110 in.
73 in. x 81 in.	73 in. x 97 in.	73 in. x 110 in.

\*Doors over 97 in. tall are subject to an additional charge

#### 4400 (KD) \*\* Product Line: D3312

##### Door size up to\*

31 in. x 81 in.	31 in. x 97 in.	31 in. x 110 in.
37 in. x 81 in.	37 in. x 97 in.	37 in. x 110 in.
49 in. x 81 in.	49 in. x 97 in.	49 in. x 110 in.
61 in. x 81 in.	61 in. x 97 in.	61 in. x 110 in.

\*\*Miter cut service available for an additional charge

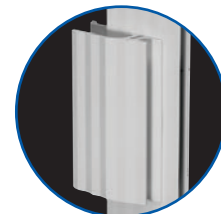
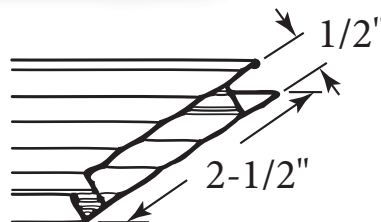

Extruded "Hat Section"  
Aluminum Screen Door

**Features**

- 2-1/4 in. x 1 in. .050 Extruded "hat section" style aluminum frame (smooth)
- Recessed handle assembly with mortise lock & slide latch
- Non-handed with handle centered
- Extruded aluminum spur corners
- Charcoal fiberglass insect screening (on assembled doors)
- 1-1/4 in. Steel ball bearing rollers
- Extruded vinyl bug seal with flap & tear-off strips
- Assembled & K.D. widths available up to 73 in.
- Assembled & K.D. heights available up to 110 in. (specify handle height on doors over 84 in. tall)  
Extra charges will apply for doors over 97 in. in height

**Standard Finishes**

- Adobe, almond, bronze or white powder coated
- Bronze or satin anodized

Call for quote on any sizes or options not shown

**3500 (Assembled)**  
Product Line: D3302

Door size up to\*

37 in. x 81 in.	37 in. x 97 in.	37 in. x 110 in.
49 in. x 81 in.	49 in. x 97 in.	49 in. x 110 in.
61 in. x 81 in.	61 in. x 97 in.	61 in. x 110 in.
73 in. x 81 in.	73 in. x 97 in.	73 in. x 110 in.

\*Doors over 97 in. tall are subject to an additional charge

**4500 (KD) \*\***  
Product Line: D3312

Door size up to\*

31 in. x 81 in.	31 in. x 97 in.	31 in. x 110 in.
37 in. x 81 in.	37 in. x 97 in.	37 in. x 110 in.
49 in. x 81 in.	49 in. x 97 in.	49 in. x 110 in.
61 in. x 81 in.	61 in. x 97 in.	61 in. x 110 in.

\*\*Miter cut service available for an additional charge

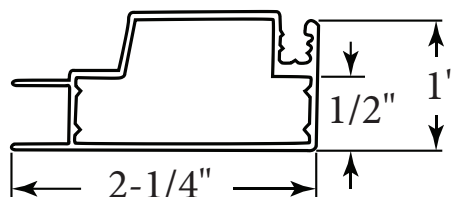
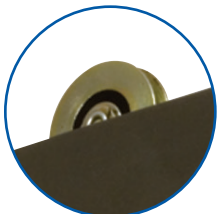



### Product Line - D3005

#### Economy Roll Form Steel Screen Door



#### Features

- 1-5/8 in. Roll form steel frame
- Height adjustable from 79-3/8 in. to 80-3/4 in. (for height adjustments between 78-1/2 in. and 79 in., remove top hood assembly)
- 30 in., 36 in. & 48 in. Standard sizes
- Black plastic handle assembly
- Non-handed
- Stamped steel corners
- Charcoal fiberglass insect screening
- Nylon spring tension roller assembly
- Top roller attached to adjustment channel
- Extruded vinyl bug seal with flap & tear-off strips
- No custom sizes or options

#### Standard Finishes

- Bronze, gray or white

#### 3700 (Assembled)

Product Line: D3005

#### Standard sizes available

30 in.
36 in.
48 in.

**Only sold in Packs of (4)**

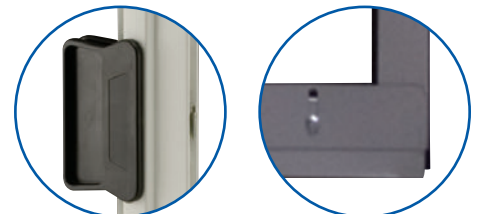

# SLIDING SCREEN DOORS

## Custom options (add-ons)

Option	Option Code	Description
<b>Door frame options</b>	OP-1PB-1	Install 1 each #288PB – 1-1/8 in. extruded push bar
	OP-1PB-2	Install 2 each #288PB – 1-1/8 in. extruded push bar
	OP-NOSLOT-HARDW	No latch, handles, rollers; no punch or slotting
	OP-SLSLOT4HNDL	Sliding door handle height; punch XX-x/x" up from bottom to
<b>Roller options</b>	OP-CLASSIC-N	Install classic side adjust nylon rollers (#477002N)
	OP-MARQUIS-NB	Slot & install Marquis nylon ball bearing rollers bottom (#4828N)
	OP-MARQUIS-NT	Slot & install Marquis nylon ball bearing rollers top (#4830)
	OP-MARQUIS-NTB	Slot & install Marquis nylon ball bearing rollers top & bottom (#4830 & #4828N)
	OP-MARQUIS-SB	Slot & install Marquis steel ball bearing rollers bottom (#4828)
	OP-MARQUIS-ST	Slot & install Marquis steel ball bearing rollers top (#4830)
	OP-MARQUIS-STB	Slot & install Marquis steel ball bearing rollers top & bottom (#4830 & #4828)
	OP-MARQUIS-SSB	Slot & install Marquis stainless steel ball bearing rollers bottom (#4828SS)
	OP-MARQUIS-SST	Slot & install Marquis stainless steel ball bearing rollers top (#4830SS)
	OP-MARQUIS-SSTB	Slot & install marquis stainless steel ball bearing rollers top & bottom (#4830SS & #4828SS)
	OP-REGAL-S	Install Regal steel rollers top & bottom #4131
	OP-REGAL-SS	Install Regal stainless steel ball bearing rollers #4131-SS
	<b>Handing options</b>	OP-HNDLLEFT
OP-HNDLRIGHT		OX"" Handle right from the outside looking in
<b>Handle options</b>	OP-1HNDL4227	Install Anjac handle #4227
	OP-1HNDL4736	Install latch & flush handle inside & out #4736 w/latch
	OP-1HNDL4736-NS	No slot/no latch, install flush handles inside & out #4736
<b>Grille options</b>	OP-GREMPRESS-30	Install Empress heavy duty grille 30 in.
	OP-GREMPRESS-36	Install Empress heavy duty grille 36 in.
	OP-GREMPRESS-48	Install Empress heavy duty grille 48 in.
	OP-GREMPRESS-60	Install Empress heavy duty grille 60 in.
	OP-GRFIESTA-30	Install Fiesta grille 30 in.
	OP-GRFIESTA-36	Install Fiesta grille 36 in.
	OP-GRFIESTA-48	Install Fiesta grille 48 in.
	OP-GRFIESTA-60	Install Fiesta grille 60 in.

# SLIDING SCREEN DOORS

Custom options (add-ons)

Option	Option Code	Description
<b>Pet door options</b>	OP-PD-SLD-S	Install pet door handle side – small w/adapter
	OP-PD-SLD-M	Install pet door handle side – medium w/adapter
	OP-PD-SLD-L	Install pet door handle side – large w/adapter
	OP-PD-SLD-XL	Install pet door handle side – extra large w/adapter
<b>Pet door colors</b>	OP-AD	Adobe
	OP-AL	Almond
	OP-BZ	Bronze
	OP-SA	Satin anodized
	OP-WH	White
<b>Screen cloth options</b>	OP-SC14CF	Screen cloth charcoal fiber 18 in. x 14 in.
	OP-SC14GF	Screen cloth gray fiber 18 in. x 14 in.
	OP-SC16BA	Screen cloth brite aluminum 18 in. x 16 in.
	OP-SC16BV	Screen cloth better vue
	OP-SC16CF	Screen cloth charcoal fiber 18 in. x 16 in.
	OP-SC16GF	Screen cloth gray fiber 18 in. x 16 in.
	OP-SCD	Delete screen cloth & spline; door shell only
	OP-SCPSBK	Screen cloth black petscreen
	OP-SCPSLBK	Screen cloth black petscreen lite
	OP-SCSTBK	Screen cloth black sun tex 80%
	OP-SCSTGR	Screen cloth gray sun tex 80%
	OP-SCSTST	Screen cloth stucco sun tex 80%

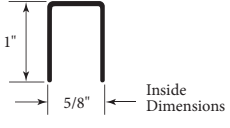
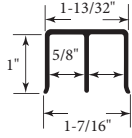
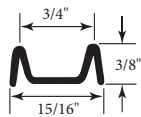
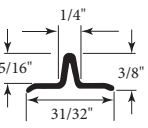
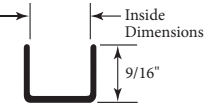
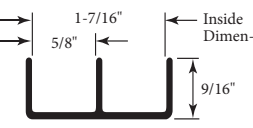
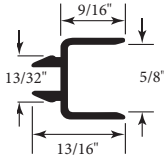

# SLIDING SCREEN COMPONENTS

Part No.	Product Line	Description	Drawing
4180xx	F3874	5/8 in. x 1 in. Top single track 12' (Available in all colors except gray)	
4181xx	F3874	5/8 in. x 1 in. Top double track 12' (Available in all colors except gray)	
4184xx	F3874	Bottom double track 12' (Available in all colors except gray)	
4185xx	F3874	Single bottom track 12' (Available in all colors except gray)	
4195xx	F3874	5/8 in. x 1/2 in. single track 12' (Available in all colors except gray)	
4196xx	F3874	1-7/16 in. x 1/2 in. double track 12' (Available in all colors except gray)	
4199xx84 4199xx	F3874	<b>Used for extruded sliders</b> Extruded screen astragal - 7' Extruded screen astragal - 8' (Available in all colors except gray)	

Color code chart (xx)
AD = Adobe
AL = Almond
BA = Bronze anodized
BK = Black
BZ = Bronze
GR = Gray
ML = Mill
SA = Satin anodized
WH = White

# SLIDING PATIO SCREEN DOOR

## Measuring worksheet

Step #1

### Determine type of header:

Determine what type of header you have; Top "track" or Top "channel" from the 2 examples in Diagram A on the right.

\*Note: If your door is something other than either of the examples in Diagram A, we recommend using installation professionals.

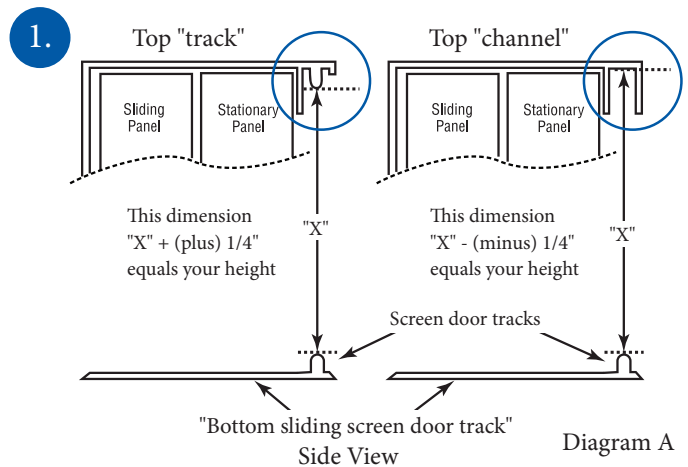

Step #2

### Determine Door Height:

To determine the height of your door, measure from the top of the screen door Top "track" or Top "channel" to the top of the "bottom sliding screen door track" as shown.

Make height measurements in 3 locations, the center and each end. There may be some "Sag", "Dip" or "Crown" along the door frame on older homes, so use the SHORTEST measurement for the final height of your door using the formula in Diagram A.

Example: using Diagram A formulas and shortest measurement for a door being 80":

"track" formula:  $80 \text{ in.} + 1/4 \text{ in.} = 80-1/4 \text{ in.}$

"channel" formula:  $80 \text{ in.} - 1/4 \text{ in.} = 79-3/4 \text{ in.}$

Net Door Height: \_\_\_\_\_ "

2.

Determine Height

3.

Determine Width

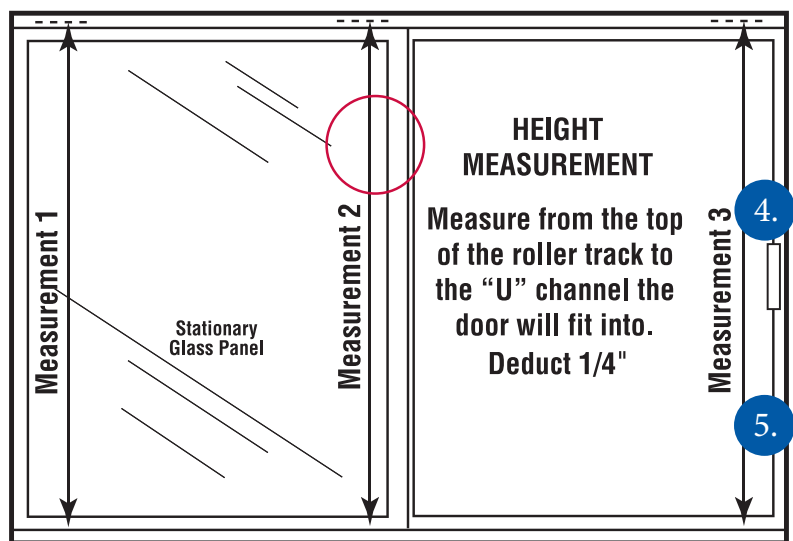

Outside view looking in

Step #3

### Determine Door Width:

To determine the width, measure from the edge of the side jamb to approximately 1 in. past the "sliding" glass door panel (see Diagram B)

Net Door Width: \_\_\_\_\_ "

Step #4

### Handle:

Please specify placement as either left or right as seen looking from the outside of the door in.

(Right hand showing in diagram)

Handle side:  Left  Right

Step #5

### Handle Height:

Handle will be centered unless specified. To order a special handle height placement, measure from the bottom of the door to center of handle.

Special Handle Height: \_\_\_\_\_ "

(Not required for normal installations)

Note: If you have an existing OEM Screen Door, compare your measurements with the size of the door that you are replacing.

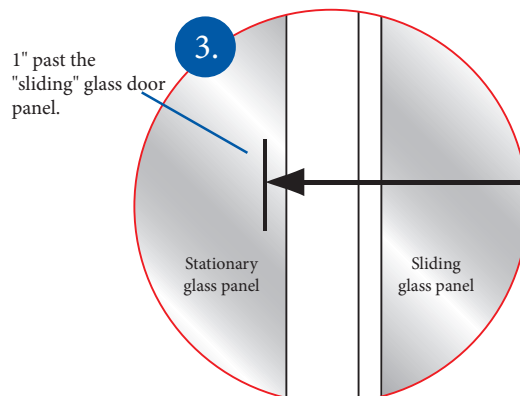

Diagram B





# SECTION 5 / GRILLES & ACCESSORIES

PRODUCT	PAGE
Swinging grilles.....	79
Sliding grilles.....	80
Custom swinging & sliding grilles .....	81

# SWINGING SCREEN DOOR GRILLES

Color code chart (xx)	
AD = Adobe	ML = Mill
AL = Almond	WH = White
BZ = Bronze	BA = Bronze Anodized
	SA = Satin Anodized

## FIESTA 27 IN. (.090 thick pattern)

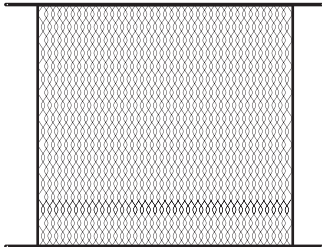

Part No.	Product Line	Description
2380xx	F3316	30 in. Swinging door grille
2381xx	F3316	32 in. Swinging door grille
2382xx	F3316	36 in. Swinging door grille
2383xx	F3316	42 in. Swinging door grille

## EMPRESS 27 IN. (.125 thick pattern)

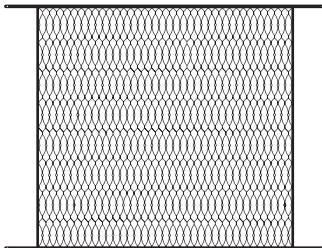

Part No.	Product Line	Description
2390xx	F3316	30 in. Swinging door grille
2391xx	F3316	32 in. Swinging door grille
2392xx	F3316	36 in. Swinging door grille
2393xx	F3316	42 in. Swinging door grille

## SWINGING DOOR GRILLE NET SIZES

For Fiesta & Empress grilles

Nominal size	Actual tip to tip	Actual body size
30 in. x 27 in.	29 in.	25 in. x 27-1/4 in.
32 in. x 27 in.	31 in.	27 in. x 27-1/4 in.
36 in. x 27 in.	35 in.	31 in. x 27-1/4 in.
42 in. x 27 in.	41 in.	37 in. x 27-1/4 in.

# SLIDING SCREEN DOOR GRILLES

Color code chart (xx)	
AD = Adobe	ML = Mill
AL = Almond	WH = White
BZ = Bronze	BA = Bronze Anodized
	SA = Satin Anodized

## FIESTA 33 IN. (.090 thick pattern)

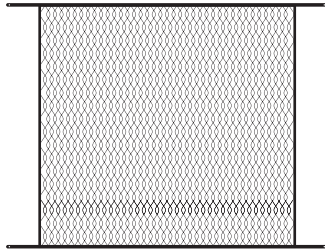

Part No.	Product Line	Description
2384xx	F3316	30 in. Sliding door grille
2385xx	F3316	36 in. Sliding door grille
2386xx	F3316	42 in. Sliding door grille
2387xx	F3316	48 in. Sliding door grille
2388xx	F3316	60 in. Sliding door grille

## EMPRESS 33 IN. (.125 thick pattern)

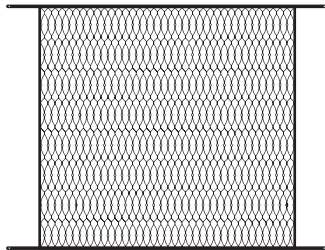

Part No.	Product Line	Description
2394xx	F3316	30 in. Sliding door grille
2395xx	F3316	36 in. Sliding door grille
2397xx	F3316	48 in. Sliding door grille
2398xx	F3316	60 in. Sliding door grille

## SLIDING DOOR GRILLE NET SIZES

For Fiesta & Empress grilles

Nominal size	Actual tip to tip	Actual body size
30 in. x 33 in.	30 in.	26 in. x 33-1/8 in.
36 in. x 33 in.	36 in.	32 in. x 33-1/8 in.
48 in. x 33 in.	48 in.	44 in. x 33-1/8 in.
60 in. x 33 in.	60 in.	56 in. x 33-1/8 in.



# CUSTOM MADE DOOR GRILLES

Color code chart (xx)	
AD = Adobe	ML = Mill
AL = Almond	WH = White
BZ = Bronze	BA = Bronze Anodized
	SA = Satin Anodized

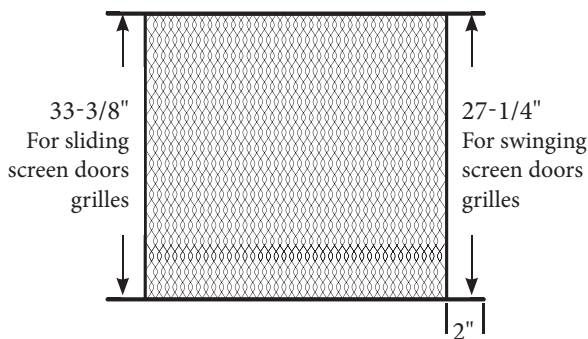

## FIESTA (.090 thick pattern)

Part No.	Product Line	Description	
		Tip To Tip	No Tips
2389xx	F3316	To 34 in. x 27 in.	To 31 in. x 27 in.
2389xx	F3316	To 36 in. x 33 in.	To 32 in. x 33 in.
2389xx	F3316	To 48 in. x 33 in.	To 44 in. x 33 in.
2389xx	F3316	To 60 in. x 33 in.	To 56 in. x 33 in.

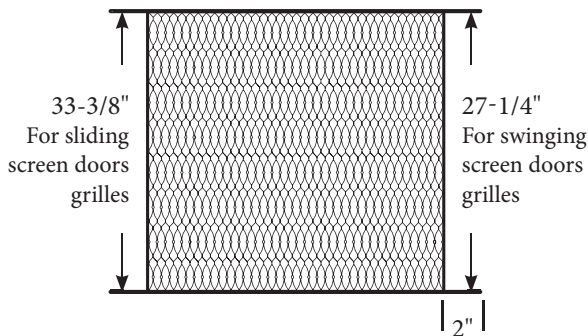

## EMPRESS (.125 thick pattern)

Part No.	Product Line	Description	
		Tip To Tip	No Tips
2399xx	F3316	To 34 in. x 27 in.	To 31 in. x 27 in.
2399xx	F3316	To 36 in. x 33 in.	To 32 in. x 33 in.
2399xx	F3316	To 48 in. x 33 in.	To 44 in. x 33 in.
2399xx	F3316	To 60 in. x 33 in.	To 56 in. x 33 in.

# SECTION 6 / PET ACCESSORIES

PRODUCT	PAGE
Pet doors, adapters, panels & accessories .....	83

## PRIDE PET DOOR HELPFUL HINTS

(PLEASE READ THIS BEFORE INSTALLING YOUR PET DOOR)



### MAKING SURE YOU HAVE THE RIGHT SIZE PET DOOR

The opening of your pet door should be 1/2 inch wider than the width of your pet's shoulder. If you have more than one pet, the door should be wide enough for the largest pet, but should be mounted low enough so the smallest pet can get through it easily. However, it is not a good idea to buy a pet door larger than your pet actually needs. Too large an opening leads to over zealous behavior and money spent on spare parts.

**HINT:** A quick and easy way to determine if the pet door is the correct size for your pet is to open your sliding glass or other house door so that the door opening is the same as the width of the pet door flap, then see if your pet can pass easily through the space. Don't worry about the height, since the pet door will be mounted according to the height of your pet.

You can use the list below to determine which Pride Pet Door model is best for your pet:

#### MODEL      SIZE OF PET

- |                    |   |
|--------------------|---|
| <b>Small</b>       | For cats or toy breeds up to 4 inches across shoulders                      |
| <b>Medium</b>      | For Beagles and Poodles, or pets up to 8 inches across shoulders.           |
| <b>Large</b>       | For German Shepherds and Boxers, or pets up to 11 inches across shoulders.  |
| <b>Extra Large</b> | For Great Danes and St. Bernards, or pets up to 14 inches across shoulders. |

### DETERMINING THE LOCATION OF YOUR PET DOOR

Your pet door can be mounted in any location where there is a surface large enough to place the frames. Some important considerations are the following:

- 1. MOUNTING HEIGHT:** Bring your pet(s) to the place where you plan to install the pet door. On the surface where pet door will be mounted, make a mark to show the height of the pet's shoulders, and another mark to show the bottom of the pet's chest. Using these marks as a guide, place your pet door so that the pet does not have to stoop or jump to go through the pet door.
- 2. LOCATION ON A HOUSE DOOR:** If you are installing the pet door on a house door, it is a good idea to locate the pet door off-center, away from the house door handle or knob. This makes it more difficult for someone to unlock the house door by reaching in through the pet door. For your security, it is recommended that a deadbolt lock be added to any house door into which a pet door is installed. Also, any gates leading to an area with a pet door should be locked.





### TEACHING YOUR PET TO USE THE PRIDE PET DOOR

With just a little help from you, your pet can quickly learn to use the pet door. Lift the flap slightly and coax the pet to come through a few times. Give him lots of praise when he comes through. If the pet is resistant, a treat or his favorite food can be useful. If your pet is highly resistant, you can tie up or remove the U-frame portion of the rubber assembly until the pet feels comfortable using the pet door. Then you can put the U-frame in its original position. Never push the pet through the opening as he may become frightened and continue to resist efforts to teach him to use the door.

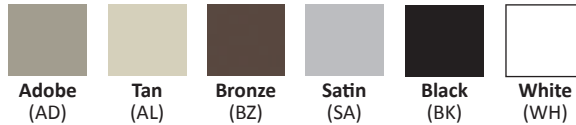
# PET ACCESSORIES

Color code chart

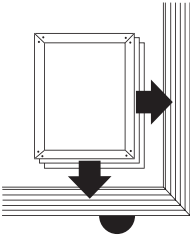

	Part No.	Product Line	Description
	2186BZ	F3900	<b>The original pet screen door (8 in. x 10 in.)</b> Bronze plastic
	2187R 2188R 2189R 2190R	F3900 F3900 F3900 F3900	<b>2 Piece rubber replacement assembly (Black)</b> For small pet door For medium pet door For large pet door For X-large pet door
	2187xx 2188xx 2189xx 2190xx	F3900 F3900 F3900 F3900	<b>Pride deluxe pet door</b> 5 in. x 7-1/8 in. small 8-1/2 in. x 12-1/2 in. medium 11-1/2 in. x 16-7/8 in. large 14-1/2 in. x 19-1/2 in. X-large <i>See color code chart for available colors</i>
	2203xx 2204xx 2205xx 2206xx	F3900 F3900 F3900 F3900	<b>Deluxe pet adapter</b> Small Medium Large X-Large <i>See color code chart for available colors</i>
	2193xx 2194xx 2195xx	F3900 F3900 F3900	<b>Pride pet panel</b> Small (6'8 in.) Medium (6'8 in.) Large (6'8 in.) <i>See color code chart for available colors</i>

Precision will custom install pet doors into your new screen door. See appropriate door section for options



## SECTION 7 / SCREEN CLOTH ROLL GOODS & SPLINE

PRODUCT	PAGE
Fiberglass screening – 18 x 14 and 18 x 16 ..... <i>Better vue, ultra vue</i>	85
Aluminum / stainless steel screening ..... <i>See vue</i>	86
Sun control products ..... <i>Sunscreen, solar insect, suntex, super solar</i>	86-87
Specialty screen products ..... <i>Petscreen, aluminum grille cloth, tuff screen</i>	87
Screen retainer spline .....	88
Order form .....	89

# FIBERGLASS SCREEN ROLL GOODS

## FIBERGLASS SCREENING 18 X 16 MESH

Charcoal & Gray (Product Line: B2000)

Charcoal (CFxx)	Gray (FGxx)	Description	Sq. Ft. Per 100' Roll
CF18	FG18	18 in. Fiberglass	150
CF24	FG24	24 in. Fiberglass	200
CF30	FG30	30 in. Fiberglass	250
CF36	FG36	36 in. Fiberglass	300
CF48	FG48	48 in. Fiberglass	400
CF60	FG60	60 in. Fiberglass	500
CF72	FG72	72 in. Fiberglass	600
CF84	FG84	84 in. Fiberglass	700

## BETTER VUE FIBERGLASS SCREENING MESH

Charcoal (Product Line: B2000)

Charcoal (BVxx)	Description	Sq. Ft. Per 100' Roll
BV24	24 in. Fiberglass	200
BV30	30 in. Fiberglass	250
BV36	36 in. Fiberglass	300
BV48	48 in. Fiberglass	400
BV60	60 in. Fiberglass	500
BV72	72 in. Fiberglass	600

## BETTER VUE FIBERGLASS SCREENING MESH ROM

Charcoal (Product Line: B2000)

Special Order Only - 2 Week Lead Time

Charcoal (BVLxx)	Description	Sq. Ft. Per 600' Roll
BVL30	30 in. Fiberglass	1500
BVL36	36 in. Fiberglass	1800
BVL48	48 in. Fiberglass	2400
BVL60	60 in. Fiberglass	3000

## FIBERGLASS SCREENING 18 X 16 MESH ROM

Charcoal & Gray (Product Line: B2002)

Charcoal (CFLxx)	Gray (GFLxx)	Description	Sq. Ft. Per 600' Roll
CFL18	GFL18	18 in. Fiberglass ROM	900
CFL24	GFL24	24 in. Fiberglass ROM	1200
CFL29	GFL29	29 in. Fiberglass ROM	1450
CFL30	GFL30	30 in. Fiberglass ROM	1500
CFL36	GFL36	36 in. Fiberglass ROM	1800
CFL48	GFL48	48 in. Fiberglass ROM	2400
CFL60	GFL60	60 in. Fiberglass ROM	3000

## ULTRA VUE FIBERGLASS SCREENING MESH ROM

Charcoal (Product Line: B2000)

Special Order Only - 2 Week Lead Time

Charcoal (UVxx)	Description	Sq. Ft. Per 100' Roll
UV24	24 in. Fiberglass ROM	200
UV36	36 in. Fiberglass ROM	300
UV48	48 in. Fiberglass ROM	400
UV60	60 in. Fiberglass ROM	500
UV72	72 in. Fiberglass ROM	600

## FIBERGLASS SCREENING 18 X 14 MESH

Charcoal & Gray (Product Line: B2001)

Charcoal (CFHxx)	Gray (FGHxx)	Description	Sq. Ft. Per 100' Roll
CFH18	FGH18	18 in. Fiberglass	150
CFH24	FGH24	24 in. Fiberglass	200
CFH30	FGH30	30 in. Fiberglass	250
CFH36	FGH36	36 in. Fiberglass	300
CFH48	FGH48	48 in. Fiberglass	400
CFH60	FGH60	60 in. Fiberglass	500
CFH72	FGH72	72 in. Fiberglass	600
CFH84	FGH84	84 in. Fiberglass	700
CFH96	FGH96	96 in. Fiberglass	800
CFH108	FGH108	108 in. Fiberglass	900

# ALUMINUM SCREEN ROLL GOODS

## ALUMINUM SCREENING 18 X 16 MESH

Silver (Product Line: B2003)

Special Order Only - 2 Week Lead Time

Silver (ALxx)	Description	Sq. Ft. Per 100' Roll
AL18	18 in. Aluminum	150
AL20	20 in. Aluminum	167
AL22	22 in. Aluminum	183
AL24	24 in. Aluminum	200
AL26	26 in. Aluminum	217
AL28	28 in. Aluminum	233
AL30	30 in. Aluminum	250
AL32	32 in. Aluminum	267
AL34	34 in. Aluminum	283
AL36	36 in. Aluminum	300
AL38	38 in. Aluminum	317
AL40	40 in. Aluminum	333
AL42	42 in. Aluminum	350
AL44	44 in. Aluminum	366
AL48	48 in. Aluminum	400
AL54	54 in. Aluminum	450
AL60	60 in. Aluminum	500
AL72	72 in. Aluminum	600

## ALUMINUM SCREENING 18 X 16 MESH

Charcoal & Black (Product Line: B2003)

Special Order Only - 2 Week Lead Time

Charcoal (CAxx)	Black (BAxxBK)	Description	Sq. Ft. Per 100' Roll
CA18	BA18BK	18 in. Aluminum	150
CA20	BA20BK	20 in. Aluminum	167
CA22	BA22BK	22 in. Aluminum	183
CA24	BA24BK	24 in. Aluminum	200
CA26	BA26BK	26 in. Aluminum	217
CA28	—	28 in. Aluminum	233
CA30	BA30BK	30 in. Aluminum	250
CA32	BA32BK	32 in. Aluminum	267
CA34	BA34BK	34 in. Aluminum	283
CA36	BA36BK	36 in. Aluminum	300
CA38	—	38 in. Aluminum	317
CA40	BA40BK	40 in. Aluminum	333
CA42	BA42BK	42 in. Aluminum	350
CA48	BA48BK	48 in. Aluminum	400
CA60	BA60BK	60 in. Aluminum	500
CA72	BA72BK	72 in. Aluminum	600

## STAINLESS STEEL SCREENING 18 X 16 MESH

(Product Line: B2000)

Special Order Only - 2 Week Lead Time

Stainless Steel (SVxx)	Description	Sq. Ft. Per 50' Roll
SV36	36 in. See vue stainless steel wire cloth	150
SV48	48 in. See vue stainless steel wire cloth	200

# SUN CONTROL SCREEN ROLL GOODS

## PHIFER SUN SCREEN

Charcoal & Gray - 70% Block (Product Line: B2006)

Special Order Only - 2 Week Lead Time

Charcoal (SCCxx)	Gray (SCGxx)	Description	Sq. Ft. Per 100' Roll
SCC24	SCG24	24 in. Sun screen	200
SCC30	SCG30	30 in. Sun screen	250
SCC36	SCG36	36 in. Sun screen	300
SCC42	SCG42	42 in. Sun screen	350
SCC48	SCG48	48 in. Sun screen	400
SCC60	SCG60	60 in. Sun screen	500
SCC72	SCG72	72 in. Sun screen	600
SCC84	SCG84	84 in. Sun screen	700

## FIBERGLASS SCREENING 20 X 20 MESH

Charcoal (Product Line: B2006)

Special Order Only - 2 Week Lead Time

Charcoal (TTBxx)	Description	Sq. Ft. Per 100' Roll
TTB36	36 in. Fiberglass	300
TTB48	48 in. Fiberglass	400
TTB60	60 in. Fiberglass	500

## SOLAR INSECT 20 X 30 MESH

Charcoal & Gray 65% Block (Product Line: B2006)

Special Order Only - 2 Week Lead Time

Charcoal (TWBxx)	Gray (TWGxx)	Description	Sq. Ft. Per 100' Roll
TWB24	TWG24	24 in. Sun control	200
TWB30	TWG30	30 in. Sun control	250
TWB36	TWG36	36 in. Sun control	300
TWB48	TWG48	48 in. Sun control	400
TWB60	TWG60	60 in. Sun control	500
TWB72	TWG72	72 in. Sun control	600
TWB84	TWG84	84 in. Sun control	700

## SUPER SOLAR

Charcoal & Gray 90% Block (Product Line: B2006)

Special Order Only - 2 Week Lead Time

Charcoal (SSCxx)	Gray (SSGxx)	Description	Sq. Ft. Per 100' Roll
SSC36	SSG36	36 in. Phifer super solar screen	300
SSC48	SSG48	48 in. Phifer super solar screen	400
SSC60	SSG60	60 in. Phifer super solar screen	500
SSC84	SSG84	84 in. Phifer super solar screen	700



# SUN CONTROL SCREEN ROLL GOODS

## SUN TEX 80

Bronze, Black, Brown Stucco & Gray - 80% Block (Product Line: B2005)

Special Order Only - 2 Week Lead Time

Bronze (STRxx)	Black (STBKxx)	Brown (STNxx)	Stucco (STSxx)	Gray (STGxx)	Description	Sq. Ft. Per 100' Roll
STR36	STBK36	STN36	STS36	STG36	36 in. Sun tex	300
STR48	STBK48	STN48	STS48	STG48	48 in. Sun tex	400
STR60	STBK60	STN60	STS60	STG60	60 in. Sun tex	500
STR72	STBK72	STN72	STS72	STG72	72 in. Sun tex	600
STR96	STBK96	STN96	STS96	STG96	96 in. Sun tex	800

## SUN TEX 90

Bronze, Black, Brown Stucco & Gray - 90% Block (Product Line: B2005)

Special Order Only - 2 Week Lead Time

Bronze (SXRxx)	Black (SXBKxx)	Brown (SXXNxx)	Stucco (SXSxx)	Gray (SXGxx)	Description	Sq. Ft. Per 100' Roll
SXR36	SXBK36	SXXN36	SXS36	SXG36	36 in. Sun tex	300
SXR48	SXBK48	SXXN48	SXS48	SXG48	48 in. Sun tex	400
SXR60	SXBK60	SXXN60	SXS60	SXG60	60 in. Sun tex	500
SXR72	SXBK72	SXXN72	SXS72	SXG72	72 in. Sun tex	600
SXR96	SXBK96	SXXN96	SXS96	SXG96	96 in. Sun tex	800

# SPECIALTY SCREEN ROLL GOODS

## PET SCREEN

Black & Gray (Product Line: B2006)

Charcoal (PSBKxx)	Gray (PSGxx)	Description	Sq. Ft. Per 100' Roll
PSBK36	PSG36	36 in. Pet screen	300
PSBK48	PSG48	48 in. Pet screen	400
PSBK60	PSG60	60 in. Pet screen	500

## ALUMINUM GRILLE CLOTH

Silver (Product Line: B2008)

Special Order Only - 2 Week Lead Time

Black (GCxx)	Description	Sq. Ft. Per 50' Roll
GC36	36 in. Aluminum grille cloth	150
GC48	48 in. Aluminum grille cloth	200

## TUFF SCREEN

Black (Product Line: B2006)

Black (TPSBKxx)	Description	Sq. Ft. Per 100' Roll
TPSBK36	36 in. Pet screen lite	300
TPSBK48	48 in. Pet screen lite	400
TPSBK60	60 in. Pet screen lite	500
TPSBK96	96 in. Pet screen lite	800























# SCREEN RETAINER SPLINE

For aluminum and fiberglass screening

## SERRATED SPLINE

Description: Top quality vinyl, round, hollow core, serrated.

Product Line: A1410

Actual Size	Size/Decimal
	.120 - 1/8 in.
	.130
	.135
	.140 - 9/64 in.
	.150
	.155 - 5/32 in.
	.165 - 11/64 in.
	.170
	.175
	.180
	.185 - 3/16 in.
	.190
	.195
	.200 - 13/64 in.
	.210 - 7/32 in.
	.215
	.220
	.225
	.230
	.235
	.250 - 1/4 in.
	.260

Bulk 15 lbs. – 1 Roll per box		Approx. Ft./15 Lb. Roll
Black	Gray	
<b>Product Line: A1410</b>		
187BK.100	N/A	
187BK.120	187GR.120	2670
187BK.125	187GR.125	
187BK.130	N/A	2400
187BK.135	187GR.135	2190
187BK.140	N/A	1920
187BK.145	N/A	1875
187BK.150	187GR.150	1815
187BK.155	N/A	1710
187BK.160	187GR.160	1600
187BK.165	187GR.165	1500
187BK.170	187GR.170	1400
187BK.175	187GR.175	1320
187BK.180	187GR.180	1200
187BK.185	187GR.185	1140
187BK.190	187GR.190	1095
187BK.195	187GR.195	1005
187BK.200	187GR.200	990
187BK.205	N/A	950
187BK.210	187GR.210	915
187BK.215	187GR.215	865
187BK.220	187GR.220	855
187BK.225	187GR.225	800
187BK.230	187GR.230	780
187BK.235	187GR.235	750
187BK.240	187GR.240	715
187BK.245	187GR.245	675
187BK.250	187GR.250	660
187BK.255	N/A	655
187BK.260	187GR.260	645

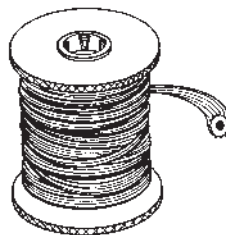

# ROLL GOODS & SPLINE ORDER FORM

**PRECISION**

2455 Wardlow Road, Corona, CA 92878



Date		P.O. No.		Placed By		Taken By		Phone No.		Acct. No.	
Bill To						Ship To					
Address						Address					
City		State		Zip		City		State		Zip	
Ship Via						Ship Date				Approved By	
		<input type="checkbox"/> U.P.S./R.P.S.		<input type="checkbox"/> _____							
Freight Prepaid & Charge						B.O. From Inv. No.				Fax No.	
		<input type="checkbox"/>		<input type="checkbox"/> C.O.D.							
	<b>Order Qty</b>	<b>Description</b>	<b>Price</b>	<b>Comments</b>		<b>Order Qty</b>	<b>Description</b>	<b>Price</b>	<b>Comments</b>		
1					27						
2					28						
3					29						
4					30						
5					31						
6					32						
7					33						
8					34						
8					35						
10					36						
11					37						
12					38						
13					39						
14					40						
15					41						
16					42						
17					43						
18					44						
19					45						
20					46						
21					47						
22					48						
23					49						
24					50						
25					51						
26					52						
		Qty./Roll Total						Qty./Roll Total			



## SECTION 8 / WINDOW SCREEN FRAME & COMPONENTS

PRODUCT	PAGE
Screen frame w/corners (1/4 in. thru 1 in.).....	91-95
Lip & stand-off screen frame .....	96
Spreader bar & clips .....	97
Screen slide channels, mullion & screen circles .....	98
Die-cast, plastic and casement screen clips.....	99
Retainer clips, pull tabs, Springs.....	100
Jiffy Hangers, Bail Latches, Plunger Latches & Slide Locks.....	101
Screen Frame Order Guide .....	102

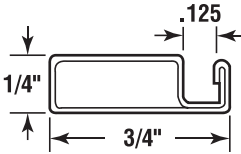

# 1/4 IN. ALUMINUM SCREEN FRAME & CORNERS

SER-123	Part No.	Length	Pcs/Carton	Ft./Carton	Thickness	Finish
3/4 in. x 1/4 in. Screen frame  Use spline size: .135 (Aluminum mesh) .150 (Fiberglass mesh)	123ML122-BX	12'2 in.	90	1095'	.020	Mill/Unpainted
	123BZ122-BX	12'2 in.	90	1095'	.020	Bronze
	123WH122-BX	12'2 in.	90	1095'	.020	White
	Part No.	Length	Pcs/Bundle	Ft./Bundle	Thickness	Finish
	123ML122-BN	12'2 in.	50	608'	.020	Mill/Unpainted
	123BZ122-BN	12'2 in.	50	608'	.020	Bronze
	123WH122-BN	12'2 in.	50	608'	.020	White
	123ML122-PK	12'2 in.	10	122'	.020	Mill/Unpainted
	123BZ122-PK	12'2 in.	10	122'	.020	Bronze
	123WH122-PK	12'2 in.	10	122'	.020	White
Part No.	Pcs/Bag	Pcs/Carton	Thickness	Finish		
3/4 in. x 1/4 in. Miter cut corner	C123ML-035	100	1000	.035	Mill/Unpainted	
						

**NOTE:**

50 piece bundles and 10 piece poly bagged packs available on most lineal items  
 Screen corners now available in 100 piece poly bags

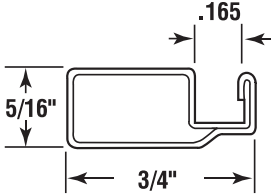
# 5/16 IN. ALUMINUM SCREEN FRAME & CORNERS

SER-520	Part No.	Length	Pcs/Carton	Ft./Carton	Thickness	Finish
<p>3/4 in. x 5/16 in. Screen frame</p>  <p>Use spline size:                      .165 (Aluminum mesh)                      .185 (Fiberglass mesh)</p>	520ML122-BX	12'2 in.	100	1217'	.020	Mill/Unpainted
	520GR122-BX	12'2 in.	100	1217'	.020	Gray
	520BK122-BX	12'2 in.	100	1217'	.020	Black
	520BZ122-BX	12'2 in.	100	1217'	.020	Bronze
	520WH122-BX	12'2 in.	100	1217'	.020	White
	520AL122-BX	12'2 in.	100	1217'	.020	Almond
	520AD122-BX	12'2 in.	100	1217'	.020	Adobe
	Part No.	Length	Pcs/Bundle	Ft./Bundle	Thickness	Finish
	520ML122-BN	12'2 in.	50	608'	.020	Mill/Unpainted
	520GR122-BN	12'2 in.	50	608'	.020	Gray
	520BK122-BN	12'2 in.	50	608'	.020	Black
	520BZ122-BN	12'2 in.	50	608'	.020	Bronze
	520WH122-BN	12'2 in.	50	608'	.020	White
	520AL122-BN	12'2 in.	50	608'	.020	Almond
	520AD122-BN	12'2 in.	50	608'	.020	Adobe
	520ML122-PK	12'2 in.	10	122'	.020	Mill/Unpainted
	520GR122-PK	12'2 in.	10	122'	.020	Gray
520BK122-PK	12'2 in.	10	122'	.020	Black	
520BZ122-PK	12'2 in.	10	122'	.020	Bronze	
520WH122-PK	12'2 in.	10	122'	.020	White	
520AL122-PK	12'2 in.	10	122'	.020	Almond	
520AD122-PK	12'2 in.	10	122'	.020	Adobe	
Part No.	Pcs/Bag	Pcs/Carton	Thickness	Finish		
3/4 in. x 5/16 in. Miter cut corner	C520ML-040	100	1000	.040	Mill/Unpainted	
						

**NOTE:**

50 piece bundles and 10 piece poly bagged packs available on most lineal items  
 Screen corners now available in 100 piece poly bags

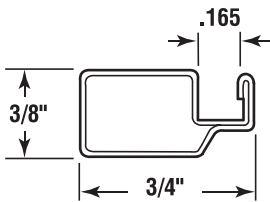

# 3/8 IN. ALUMINUM SCREEN FRAME & CORNERS

SER-519	Part No.	Length	Pcs/Carton	Ft./Carton	Thickness	Finish
<p>3/4 in. x 3/8 in. Screen frame</p>  <p>SER-519 = .020 SER-519H = .025</p> <p>Use spline size: .165 (Aluminum mesh) .185 (Fiberglass mesh)</p>	519ML122-BX	12'2 in.	100	1217'	.020	Mill/Unpainted
	519GR122-BX	12'2 in.	100	1217'	.020	Gray
	519BK122-BX	12'2 in.	100	1217'	.020	Black
	519BZ122-BX	12'2 in.	100	1217'	.020	Bronze
	519WH122-BX	12'2 in.	100	1217'	.020	White
	519AL122-BX	12'2 in.	100	1217'	.020	Almond
	519AD122-BX	12'2 in.	100	1217'	.020	Adobe
	Part No.	Length	Pcs/Bundle	Ft./Bundle	Thickness	Finish
	519ML122-BN	12'2 in.	50	608'	.020	Mill/Unpainted
	519GR122-BN	12'2 in.	50	608'	.020	Gray
	519BK122-BN	12'2 in.	50	608'	.020	Black
	519BZ122-BN	12'2 in.	50	608'	.020	Bronze
	519WH122-BN	12'2 in.	50	608'	.020	White
	519AL122-BN	12'2 in.	50	608'	.020	Almond
	519AD122-BN	12'2 in.	50	608'	.020	Adobe
	519ML122-PK	12'2 in.	10	122'	.020	Mill/Unpainted
	519GR122-PK	12'2 in.	10	122'	.020	Gray
	519BK122-PK	12'2 in.	10	122'	.020	Black
	519BZ122-PK	12'2 in.	10	122'	.020	Bronze
	519WH122-PK	12'2 in.	10	122'	.020	White
	519AL122-PK	12'2 in.	10	122'	.020	Almond
	519AD122-PK	12'2 in.	10	122'	.020	Adobe
	Part No.	Length	Pcs/Carton	Ft./Carton	Thickness	Finish
	519ML122H-BX	12'2 in.	100	1217'	.025	Mill/Unpainted
	519GR122H-BX	12'2 in.	100	1217'	.025	Gray
	519BZ122H-BX	12'2 in.	100	1217'	.025	Bronze
	519WH122H-B	12'2 in.	100	1217'	.025	White
	Part No.	Length	Pcs/Bundle	Ft./Bundle	Thickness	Finish
519ML122H-BN	12'2 in.	50	608'	.025	Mill/Unpainted	
519GR122H-BN	12'2 in.	50	608'	.025	Gray	
519BZ122H-BN	12'2 in.	50	608'	.025	Bronze	
519WH122H-BN	12'2 in.	50	608'	.025	White	
519ML122H-PK	12'2 in.	10	122'	.025	Mill/Unpainted	
519GR122H-PK	12'2 in.	10	122'	.025	Gray	
519BZ122H-PK	12'2 in.	10	122'	.025	Bronze	
519WH122H-PK	12'2 in.	10	122'	.025	White	
Part No.	Pcs/Bag	Pcs/Carton	Thickness	Finish		
3/4 in. x 3/8 in. Miter cut corner	C519ML-050	100	1000	.050	Mill/Unpainted	

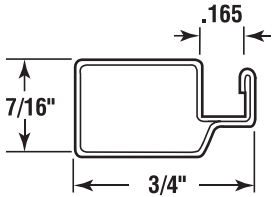

# 7/16 IN. ALUMINUM SCREEN FRAME & CORNERS

SER-516	Part No.	Length	Pcs/Carton	Ft./Carton	Thickness	Finish
<p>3/4 in. x 7/16 in. Screen frame</p>  <p>SER-515 = .025 SER-516 = .020</p> <p>Use spline size: .165 (Aluminum mesh) .185 (Fiberglass mesh)</p>	516ML122-BX	12'2 in.	100	1217'	.020	Mill/Unpainted
	516GR122-BX	12'2 in.	100	1217'	.020	Gray
	516BZ122-BX	12'2 in.	100	1217'	.020	Bronze
	516WH122-BX	12'2 in.	100	1217'	.020	White
	516AL122-BX	12'2 in.	100	1217'	.020	Almond
	516AD122-BX	12'2 in.	100	1217'	.020	Adobe
	Part No.	Length	Pcs/Bundle	Ft./Bundle	Thickness	Finish
	516ML122-BN	12'2 in.	50	608'	.020	Mill/Unpainted
	516GR122-BN	12'2 in.	50	608'	.020	Gray
	516BZ122-BN	12'2 in.	50	608'	.020	Bronze
	516WH122-BN	12'2 in.	50	608'	.020	White
	516AL122-BN	12'2 in.	50	608'	.020	Almond
	516AD122-BN	12'2 in.	50	608'	.020	Adobe
	516ML122-PK	12'2 in.	10	122'	.020	Mill/Unpainted
	516GR122-PK	12'2 in.	10	122'	.020	Gray
	516BZ122-PK	12'2 in.	10	122'	.020	Bronze
	516WH122-PK	12'2 in.	10	122'	.020	White
	516AL122-PK	12'2 in.	10	122'	.020	Almond
	516AD122-PK	12'2 in.	10	122'	.020	Adobe
	Part No.	Length	Pcs/Carton	Ft./Carton	Thickness	Finish
	515ML122-BX	12'2 in.	100	1217'	.025	Mill/Unpainted
	515GR122-BX	12'2 in.	100	1217'	.025	Gray
	515BZ122-BX	12'2 in.	100	1217'	.025	Bronze
	515WH122-BX	12'2 in.	100	1217'	.025	White
	Part No.	Length	Pcs/Bundle	Ft./Bundle	Thickness	Finish
	515ML122-BN	12'2 in.	50	608'	.025	Mill/Unpainted
	515GR122-BN	12'2 in.	50	608'	.025	Gray
	515BZ122-BN	12'2 in.	50	608'	.025	Bronze
515WH122-BN	12'2 in.	50	608'	.025	White	
515ML122-PK	12'2 in.	10	122'	.025	Mill/Unpainted	
515GR122-PK	12'2 in.	10	122'	.025	Gray	
515BZ122-PK	12'2 in.	10	122'	.025	Bronze	
515WH122-PK	12'2 in.	10	122'	.025	White	
Part No.	Pcs/Bag	Pcs/Carton	Thickness	Finish		
3/4 in. x 7/16 in. Miter cut corner	C515ML-050	100	1000	.050	Mill/Unpainted	

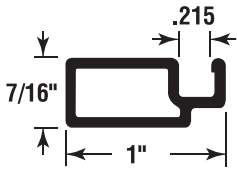
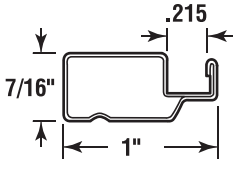

# 1 IN. ALUMINUM SCREEN FRAME & CORNERS

Item packs marked with "\*"available in less than pack quantities

SER-114		Part No.	Length	Pcs/Carton	Ft./Carton	Thickness	Finish
1 in. Extruded screen frame  <p>Use spline size:            .235 (Aluminum mesh)            .250 (Fiberglass mesh)  <b>Use corner C114ML-040</b></p>	114ML122-BX	12'2 in.	50	608'	.050	Mill/Unpainted	
	114SA122-BX	12'2 in.	50	608'	.050	Satin anodized	
	114BZ122-BX	12'2 in.	50	608'	.050	Bronze	
	114BA122-BX	12'2 in.	50	608'	.050	Bronze anodized	
	114WH122-BX	12'2 in.	50	608'	.050	White	
	114AL122-BX	12'2 in.	50	608'	.050	Almond	
	Part No.	Length	Pcs/Bundle	Ft./Bundle	Thickness	Finish	
	114ML122-PK	12'2 in.	10*	122'	.050	Mill/Unpainted	
	114SA122-PK	12'2 in.	10*	122'	.050	Satin anodized	
	114BZ122-PK	12'2 in.	10*	122'	.050	Bronze	
	114BA122-PK	12'2 in.	10*	122'	.050	Bronze anodized	
	114WH122-PK	12'2 in.	10*	122'	.050	White	
	114AL122-PK	12'2 in.	10*	122'	.050	Almond	
	SER-112		Part No.	Length	Pcs/Carton	Ft./Carton	Thickness
 <p>SER-112 = .032            SER-513 = .025            Use spline size:            .235 (Aluminum mesh)            .250 (Fiberglass mesh)</p>	513ML122-BX	12'2 in.	84	1022'	.025	Mill/Unpainted	
	513GR122-BX	12'2 in.	84	1022'	.025	Gray	
	513BZ122-BX	12'2 in.	84	1022'	.025	Bronze	
	513WH122-BX	12'2 in.	84	1022'	.025	White	
	513AL122-BX	12'2 in.	84	1022'	.025	Almond	
	513AD122-BX	12'2 in.	84	1022'	.025	Adobe	
	Part No.	Length	Pcs/Bundle	Ft./Bundle	Thickness	Finish	
	513ML122-PK	12'2 in.	10	122'	.025	Mill/Unpainted	
	513GR122-PK	12'2 in.	10	122'	.025	Gray	
	513BZ122-PK	12'2 in.	10	122'	.025	Bronze	
	513WH122-PK	12'2 in.	10	122'	.025	White	
	513AL122-PK	12'2 in.	10	122'	.025	Almond	
	513AD122-PK	12'2 in.	10	122'	.025	Adobe	
			Part No.		Pcs/Bag	Pcs/Carton	Thickness
1 in. x 7/16 in. Miter cut corner 		C114ML-040		100	1000	0.04	Mill/Unpainted
		C513ML-060		100	1000	0.06	Mill/Unpainted



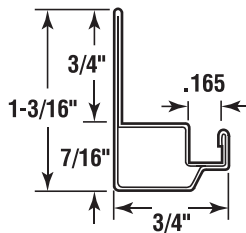
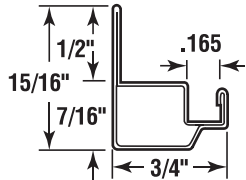
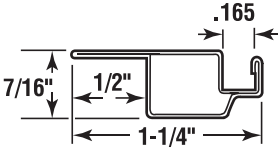
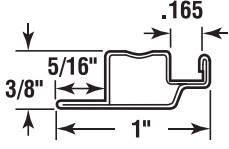

# LIP & STAND-OFF ALUMINUM SCREEN FRAME

SER-124	Part No.	Length	Pcs/Carton	Ft./Carton	Thickness	Finish	
3/4 in. Stand-off frame  Use corner C115ML-xxx	124ML122-BX	12'2 in.	60	730'	.025	Mill/Unpainted	
	124GR122-BX	12'2 in.	60	730'	.025	Gray	
	124BZ122-BX	12'2 in.	60	730'	.025	Bronze	
	124WH122-BX	12'2 in.	60	730'	.025	White	
	124AL122-BX	12'2 in.	60	730'	.025	Almond	
	124AD122-BX	12'2 in.	60	730'	.025	Adobe	
	Part No.	Length	Pcs/Bundle	Ft./Bundle	Thickness	Finish	
	124ML122-PK	12'2 in.	10	122'	.025	Mill/Unpainted	
	124GR122-PK	12'2 in.	10	122'	.025	Gray	
	124BZ122-PK	12'2 in.	10	122'	.025	Bronze	
	124WH122-PK	12'2 in.	10	122'	.025	White	
	124AL122-PK	12'2 in.	10	122'	.025	Almond	
	124AD122-PK	12'2 in.	10	122'	.025	Adobe	
SER-129	Part No.	Length	Pcs/Carton	Ft./Carton	Thickness	Finish	
1/2 in. Stand-off frame  Use corner C115ML-040 or AC115BK (adjustable)	129ML122-BX	12'2 in.	90	1095'	.025	Mill/Unpainted	
	129GR122-BX	12'2 in.	90	1095'	.025	Gray	
	129BZ122-BX	12'2 in.	90	1095'	.025	Bronze	
	129WH122-BX	12'2 in.	90	1095'	.025	White	
	Part No.	Length	Pcs/Bundle	Ft./Bundle	Thickness	Finish	
	129ML122-PK	12'2 in.	10	122'	.025	Mill/Unpainted	
	129GR122-PK	12'2 in.	10	122'	.025	Gray	
	129BZ122-PK	12'2 in.	10	122'	.025	Bronze	
	129WH122-PK	12'2 in.	10	122'	.025	White	
	SER-118	Part No.	Length	Pcs/Carton	Ft./Carton	Thickness	Finish
	1/2 in. Lip frame  Use corner C115ML-040 or AC115BK (adjustable)	118ML122-BX	12'2 in.	70	852'	.025	Mill/Unpainted
		118GR122-BX	12'2 in.	70	852'	.025	Gray
		118BK122-BX	12'2 in.	70	852'	.025	Black
118BZ122-BX		12'2 in.	70	852'	.025	Bronze	
118WH122-BX		12'2 in.	70	852'	.025	White	
Part No.		Length	Pcs/Bundle	Ft./Bundle	Thickness	Finish	
118ML122-PK		12'2 in.	10	122'	.025	Mill/Unpainted	
118GR122-PK		12'2 in.	10	122'	.025	Gray	
118BK122-PK		12'2 in.	10	122'	.025	Black	
118BZ122-PK		12'2 in.	10	122'	.025	Bronze	
118WH122-PK		12'2 in.	10	122'	.025	White	
SER-117		Part No.	Length	Pcs/Carton	Ft./Carton	Thickness	Finish
5/16 in. Lip frame  All above use spline size: .165 (Aluminum mesh) .185 (Fiberglass mesh) Use corner C117ML-020		117ML122-BX	12'2 in.	120	1460'	.020	Mill/Unpainted
	117GR122-BX	12'2 in.	120	1460'	.020	Gray	
	117BZ122-BX	12'2 in.	120	1460'	.020	Bronze	
	117WH122-BX	12'2 in.	120	1460'	.020	White	
	117AL122-BX	12'2 in.	120	1460'	.020	Almond	
	117AD122-BX	12'2 in.	120	1460'	.020	Adobe	
	Part No.	Length	Pcs/Bundle	Ft./Bundle	Thickness	Finish	
	117ML122-PK	12'2 in.	10	122'	.020	Mill/Unpainted	
	117GR122-PK	12'2 in.	10	122'	.020	Gray	
	117BZ122-PK	12'2 in.	10	122'	.020	Bronze	
	117WH122-PK	12'2 in.	10	122'	.020	White	
	117AL122-PK	12'2 in.	10	122'	.020	Almond	
	117AD122-PK	12'2 in.	10	122'	.020	Adobe	
Corners	Description	Part No.	Pcs/Bag	Pcs/Carton	Thickness	Finish	
	5/16 in. Lip frame corner	C117ML-020	100	1000	.020	Mill/Unpainted	
	3/4 in. x 7/16 in. Miter cut corner	C115ML-040	100	1000	.040	Mill/Unpainted	
	3/4 in. x 7/16 in. Miter cut corner	C115ML-050	100	1000	.050	Mill/Unpainted	

# ALUMINUM SCREEN FRAME SPREADER BAR

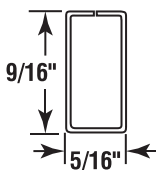
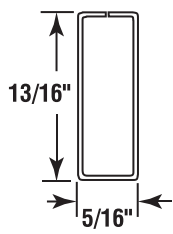
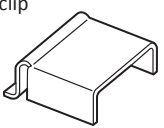
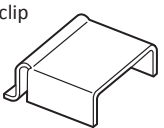
SER-128	Part No.	Length	Pcs/Carton	Ft./Carton	Thickness	Finish
5/8 in. Spreader bar 	128ML120-BX	12'0 in.	100	1200'	.025	Mill/Unpainted
	128GR120-BX	12'0 in.	100	1200'	.025	Gray
	128BZ120-BX	12'0 in.	100	1200'	.025	Bronze
	128WH120-BX	12'0 in.	100	1200'	.025	White
	128AL120-BX	12'0 in.	100	1200'	.025	Almond
	128AD120-BX	12'0 in.	100	1200'	.025	Adobe
	Part No.	Length	Pcs/Bundle	Ft./Bundle	Thickness	Finish
	128ML120-BN	12'0 in.	50	600'	.025	Mill/Unpainted
	128GR120-BN	12'0 in.	50	600'	.025	Gray
	128BZ120-BN	12'0 in.	50	600'	.025	Bronze
	128WH120-BN	12'0 in.	50	600'	.025	White
	128AL120-BN	12'0 in.	50	600'	.025	Almond
	128AD120-BN	12'0 in.	50	600'	.025	Adobe
	128ML120-PK	12'0 in.	10	120'	.025	Mill/Unpainted
	128GR120-PK	12'0 in.	10	120'	.025	Gray
	128BZ120-PK	12'0 in.	10	120'	.025	Bronze
	128WH120-PK	12'0 in.	10	120'	.025	White
	128AL120-PK	12'0 in.	10	120'	.025	Almond
	128AD120-PK	12'0 in.	10	120'	.025	Adobe
SER-127	Part No.	Length	Pcs/Carton	Ft./Carton	Thickness	Finish
7/8 in. Spreader bar 	127ML120-BX	12'0 in.	75	900'	.030	Mill/Unpainted
	127GR120-BX	12'0 in.	75	900'	.030	Gray
	127BZ120-BX	12'0 in.	75	900'	.030	Bronze
	127WH120-BX	12'0 in.	75	900'	.030	White
	127AL120-BX	12'0 in.	75	900'	.030	Almond
	127AD120-BX	12'0 in.	75	900'	.030	Adobe
	Part No.	Length	Pcs/Bundle	Ft./Bundle	Thickness	Finish
	127ML120-PK	12'0 in.	10	120'	.030	Mill/Unpainted
	127GR120-PK	12'0 in.	10	120'	.030	Gray
	127BZ120-PK	12'0 in.	10	120'	.030	Bronze
	127WH120-PK	12'0 in.	10	120'	.030	White
	127AL120-PK	12'0 in.	10	120'	.030	Almond
	127AD120-PK	12'0 in.	10	120'	.030	Adobe
	Part No.	Pcs/Bag	Pcs/Carton	Finish		
7/8 in. Spreader bar clip	159ML	100	1000	Mill/Unpainted		
						
Part No.	Pcs/Bag	Pcs/Carton	Finish			
5/8 in. Spreader bar clip	160ML	100	1000	Mill/Unpainted		
						

# ALUMINUM SCREEN FRAME ACCESSORIES

Special Order Only - 2 Week Lead Time

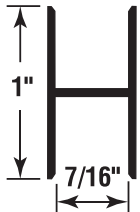
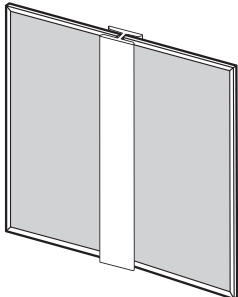
SER-130	Part No.	Length	Pcs/Carton	Ft./Carton	Thickness	Finish
7/16 in. Extruded in.H in. section  	130ML122-BX	12'2 in.	50	610'	.025	Mill/Unpainted
	130SA122-BX	12'2 in.	50	610'	.025	Satin anodized
	130BZ122-BX	12'2 in.	50	610'	.025	Bronze
	130WH122-BX	12'2 in.	50	610'	.025	White
	130AL122-BX	12'2 in.	50	610'	.025	Almond
	130AD122-BX	12'2 in.	50	610'	.025	Adobe
	Part No.	Length	Pcs/Bundle	Ft./Bundle	Thickness	Finish
	130ML122-PK	12'2 in.	10	122'	.025	Mill/Unpainted
	130SA122-PK	12'2 in.	10	122'	.025	Satin anodized
	130BZ122-PK	12'2 in.	10	122'	.025	Bronze
	130WH122-PK	12'2 in.	10	122'	.025	White
	130AL122-PK	12'2 in.	10	122'	.025	Almond
	130AD122-PK	12'2 in.	10	122'	.025	Adobe
	130ML122-EA	12'2 in.	1	12'2 in.	.025	Mill/Unpainted
130SA122-EA	12'2 in.	1	12'2 in.	.025	Satin anodized	
130BZ122-EA	12'2 in.	1	12'2 in.	.025	Bronze	
130WH122-EA	12'2 in.	1	12'2 in.	.025	White	
130AL122-EA	12'2 in.	1	12'2 in.	.025	Almond	
130AD122-EA	12'2 in.	1	12'2 in.	.025	Adobe	

SER-185	Part No.	Description	Diameters (all colors)	Finish
1 in. Screen frame circles  <i>Only sold in packs of (5)</i>	185GR.xx	.025 Ga. 1 in. Screen frame circles Full circles only	24 in., 30 in., 36 in. 42 in., 48 in., 60 in. 72 in., 84 in., 96 in.	Gray
	185BZ.xx			Bronze
	185WH.xx			White
	185AL.xx			Almond
	185AD.xx			Adobe

**NOTE:**

50 piece bundles and 10 piece poly bagged packs available on most lineal items  
 Screen corners now available in 100 piece poly bags



# SCREEN FRAME ACCESSORIES

## DIECAST SCREEN CLIPS (Product Line: A1211)

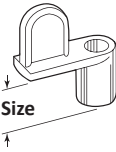
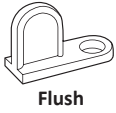

Size	Use screw #	Pack QTY	Adobe	Almond	Black	Bronze	Mill	White
Flush	#1052 Screw (10-24 x 5/8 in. S/T)	1000/Box	1660AD	1660AL	1660BK	1660BZ	1660ML	1660WH
1/16 in.	#1052 Screw (10-24 x 5/8 in. S/T)	1000/Box	1661AD	1661AL	1661BK	1661BZ	1661ML	1661WH
1/8 in.	#1052 Screw (10-24 x 5/8 in. S/T)	100/Bag	1662AD	1662AL	1662BK	1662BZ	1662ML	1662WH
3/16 in.	#1052 Screw (10-24 x 5/8 in. S/T)	100/Bag	1663AD	1663AL	1663BK	1663BZ	1663ML	1663WH
1/4 in.	#1052 Screw (10-24 x 5/8 in. S/T)	100/Bag	1664AD	1664AL	1664BK	1664BZ	1664ML	1664WH
5/16 in.	#1052 Screw (10-24 x 5/8 in. S/T)	100/Bag	1665AD	1665AL	1665BK	1665BZ	1665ML	1665WH
3/8 in.	#1052 Screw (10-24 x 5/8 in. S/T)	100/Bag	1666AD	1666AL	1666BK	1666BZ	1666ML	1666WH
7/16 in.	#1053 Screw (10-24 x 3/4 in. S/T)	100/Bag	1667AD	1667AL	1667BK	1667BZ	1667ML	1667WH
1-3/16 in.	#1055 Screw (10-24 x 1-5/8 in. S/T)	100/Bag	1668AD	1668AL	1668BK	1668BZ	1668ML	1668WH

All clips available in 1000 pieces per carton

## CASEMENT CLIPS (Product Line: D1310)

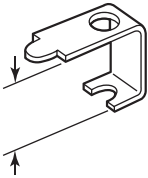

Size	Use screw #	Pack QTY	Part No.	Finish
5/16 in.	#1052 Screw (10-24 x 5/8 in. S/T)	1000/Ctn.	1780ML	Mill
3/8 in.	#1053 Screw (10-24 x 3/4 in. S/T)	1000/Ctn.	179ML	Mill
7/16 in.	#1053 Screw (10-24 x 3/4 in. S/T)	1000/Ctn.	180ML	Mill
7/8 in.	#1054 Screw (10-24 x 1-1/4 in. S/T)	1000/Ctn.	181ML	Mill
1-3/16 in.	#1055 Screw (10-24 x 1-5/8 in. S/T)	1000/Ctn.	182ML	Mill



# SCREEN FRAME ACCESSORIES

## RETAINER CLIPS & PULL TABS (Product Line: D1310)

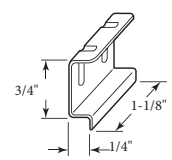
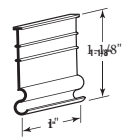
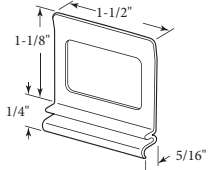
	Description	Material	Pack QTY	Mill	Black	White	Gray
	Spline channel pull tabs	Aluminum	1000/Ctn.	152ML	—	152WH	—
	Spline channel pull tabs	Plastic	1000/Ctn.	—	153BK	—	153GR
	Spline channel pull tabs	Plastic	1000/Ctn.	—	154BK	—	—

## SPRINGS (Product Line: D1310)

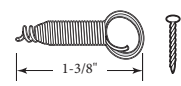
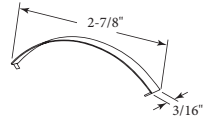
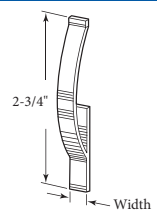
	Description	Material	Pack QTY	Part No.
	Bottom latch springs	Stainless steel	1000/Ctn.	1550SS
	Flat springs	Spring steel	1000/Ctn.	1510ZP
	Flat springs <b>1/4 in. wide</b>	Spring steel	1000/Ctn.	1490ZP
	Flat springs <b>3/16 in. wide</b>	Spring steel	1000/Ctn.	1560ZP

# SCREEN FRAME ACCESSORIES

## JIFFY HANGERS & BAIL LATCHES

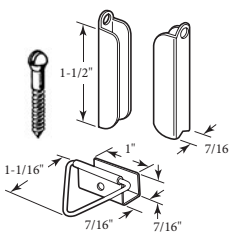
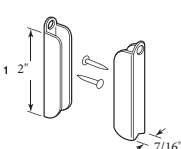
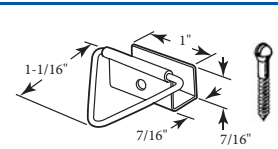
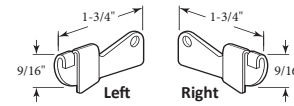
	Material	Pack QTY	Finish	Part No.	Product Line
(2) Hangers & (1) latch <b>For 7/16 in. frame</b>  <b>1 Set contains:</b> 2 Hangers, 1 latch, (2) 13 x 3/4 in. spiral steel nails & 1 ball head screw  	Aluminum	250 Sets / Box	Mill	146ML	A1210
	Aluminum	250 Sets / Box	Bronze	146BZ	A1210
	Aluminum	250 Sets / Box	White	146WH	A1210
	Aluminum	250 Sets / Box	Gray	146GR	A1210
Top hangers <b>For 7/16 in. frame</b> w/spiral steel nails  	Aluminum	1000 / Box	Mill	144ML	A1210
	Aluminum	1000 / Box	Bronze	144BZ	A1210
	Aluminum	1000 / Box	White	144WH	A1210
	Aluminum	1000 / Box	Gray	144GR	A1210
Bottom latches <b>For 7/16 in. frame</b>  	Aluminum	1000 / Box	Mill	145ML	A1210
	Aluminum	1000 / Box	Bronze	145BZ	A1210
	Aluminum	1000 / Box	White	145WH	A1210
	Aluminum	1000 / Box	Gray	145GR	A1210
Knife latches Use notching tool #9025  	Aluminum	100 Pair	Mill	175ML	D1310

## PLUNGER LATCHES & SLIDE LOCKS (SPECIAL ORDER)

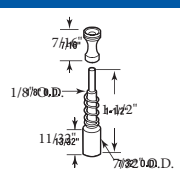
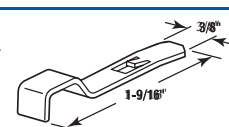
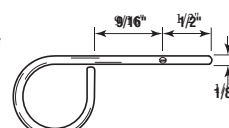
	Material	Pack QTY	Part No.	Product Line
Plunger latches <b>For 3/4 in. x 3/8 in.</b> <b>(or 7/16 in.) frame</b>  Use step drill #9017  <b>NAIL SET</b> <b>STYLE</b>  	All aluminum	100 Sets	176ML	D1310
Slide lock <b>For all 3/4 in. frames</b>  	Zinc plated steel	1000/Ctn.	161ML	D1310
Lock pins <b>For all 3/4 in. frames</b>  	Steel	1000/Ctn.	1580CP	D1310

1/8"

# WINDOW SCREEN ORDER FORM

CUSTOMER NAME :	DATE :
-----------------	--------

PO NUMBER:	QTY :
------------	-------

**SCREEN FRAME TYPE (CHECK ONE)**

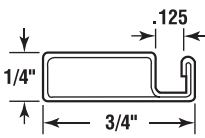

**SER-123** (pg. 98)

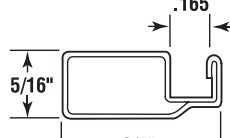

**SER-520** (pg. 99)

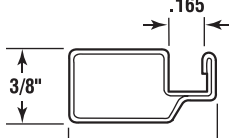

**SER-519** (pg. 100)

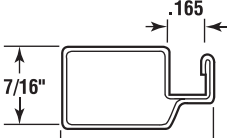

**SER-516** (pg. 101)

**SCREEN FRAME COLOR (CHECK ONE)**

GREY     
  MILL     
  WHITE     
  BRONZE     
  ALMOND

**SCREEN CLOTH TYPE (CHECK ONE)**

Charcoal Fiber 18x16 (STD)

Gray Fiber 18x16 (STD)

Better Vue

Brite Aluminum 18x16

Charcoal Fiber 18x14

Gray Fiber 18x14

No Screen Cloth/Spline

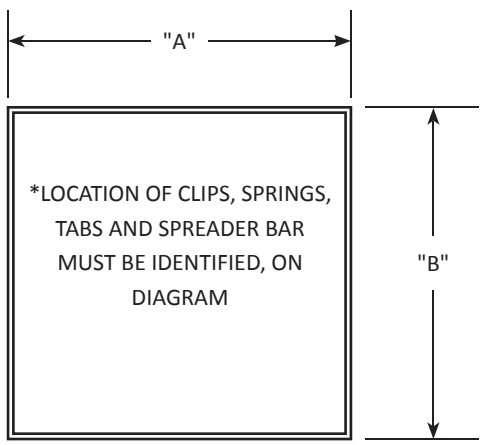

"A" WIDTH \_\_\_\_\_ "B" HEIGHT \_\_\_\_\_

**OPTIONAL HARDWARE**

INSTALL PULL TABS (153)

INSTALL SPREADER BAR

INSTALL LIFT CLIP (152ML)

INSTALL FLAT SPRINGS (1490ZP)





# SECTION 9 / TOOLS & SUPPLIES

PRODUCT	PAGE
Rolling tools & replacement wheels.....	104
Fasteners & rivets .....	104
one way tool, adapter, & spray paint.....	105



# SCREEN ROLLING & SPECIALTY TOOLS

All wood handles

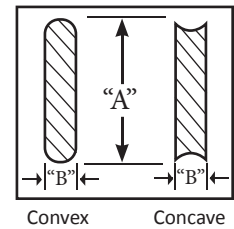

Product Line: K2500	Part No.	Wheel	Convex		Concave		Spline size
			A	B	A	B	
	PNSR-6000	Nylon	—	—	2 in.	3/32 in.	.115 - .145
	PNSR-6100	Nylon	—	—	2 in.	1/8 in.	.150 - .180
	PNSR-6200	Nylon	—	—	2 in.	5/32 in.	.185 - .215
	PNSR-6300	Nylon	—	—	2 in.	3/16 in.	.220 - .260
	PCR-7-20	Steel	2 in.	1/16 in.	2 in.	1/8 in.	.150 - .180
	PCR-6-22	Steel	2-1/2 in.	1/16 in.	2 in.	3/32 in.	.115 - .145
	PCR-7-22	Steel	2-1/2 in.	1/16 in.	2 in.	1/8 in.	.150 - .180
	PCR-8-22	Steel	2-1/2 in.	1/16 in.	2 in.	5/32 in.	.185 - .215
	PFR-4000 Flat roller	Steel	2 in. x 2 in. Flat				

Wheel measurements



## MISCELLANEOUS TOOLS & SHOP SUPPLIES

### SCREWS



	Part No.	Product Line	Pack QTY	Description
<b>Screen clip screws</b> Phillips pan head-self tapping 	1052	K2606	100/Ctn.	10-24 x 5/8 in. (Plated)
	1053	K2606	100/Ctn.	10-24 x 3/4 in. (Plated)
	1054	K2606	100/Ctn.	10-24 x 1-1/4 in. (Plated)
	1055	K2606	100/Ctn.	10-24 x 1-5/8 in. (Plated)
<b>Ball head screws</b> Slotted ball head 	1068	K2604	100/Ctn.	8 x 1-1/4 in. (Ball latch screws)

### BLIND RIVETS

	Part No.	Product Line	Description	Body length	Grip range
<b>Aluminum rivets</b> w/carbon steel mandrels 1/8 in. Dia. 	1082	K2608	AD 41 BS	.170	.020 - .064
	1083	K2608	AD 42 BS	.232	.065 - .125
	1084	K2608	AD 43 BS	.294	.126 - .187
	1085 (Steel)	K2608	AD 44 BS	.357	.188 - .250
	1086	K2608	AD 45 BS	.415	.251 - .312
	1087	K2608	AD 46 BS	.481	.313 - .375

*\*Specify adobe, almond, black, bronze, or white*

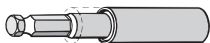
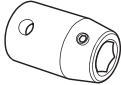
# MISCELLANEOUS TOOLS & SHOP SUPPLIES

	Part No.	Product Line	Pack QTY	Description
<b>One way tool</b> 	8900	G8100	1	5/16 in. One way driving tool
<b>Adapter</b> 	8901	G8100	1	5/16 in. Drive tool adapter, used for 1/2 in. square drive
<b>Precision spray paint</b> (12 oz. Aerosol Can) 	8720 8721 8722 8723 8727 8757	G8705	12/Case	Semi gloss black Bronze Semi-gloss white Almond Adobe Weathered brown